

# PL

Einrichtung Design  
SINCE 1999

ITALIAN DESIGN SINCE 1993

CATALISTINO  
CONTRACT  
PREZZI PUBBLICO

INDOOR  
OUTDOOR  
OFFICE  
COMUNITÀ  
STANDING

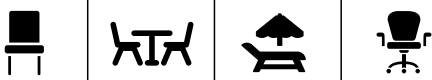

AGGIORNAMENTO TECNICO 10.10.23

32.000 mt di

unità operative

OLTRE 1 MILIONE  
DI COLLI

IN PRONTA  
CONSEGNA

NB: i prodotti identificati con questa scritta

**NORMALMENTE IN PRONTA CONSEGNA**

sono quelli a magazzino,  
normalmente disponibili subito

### INDICE PER FAMIGLIE

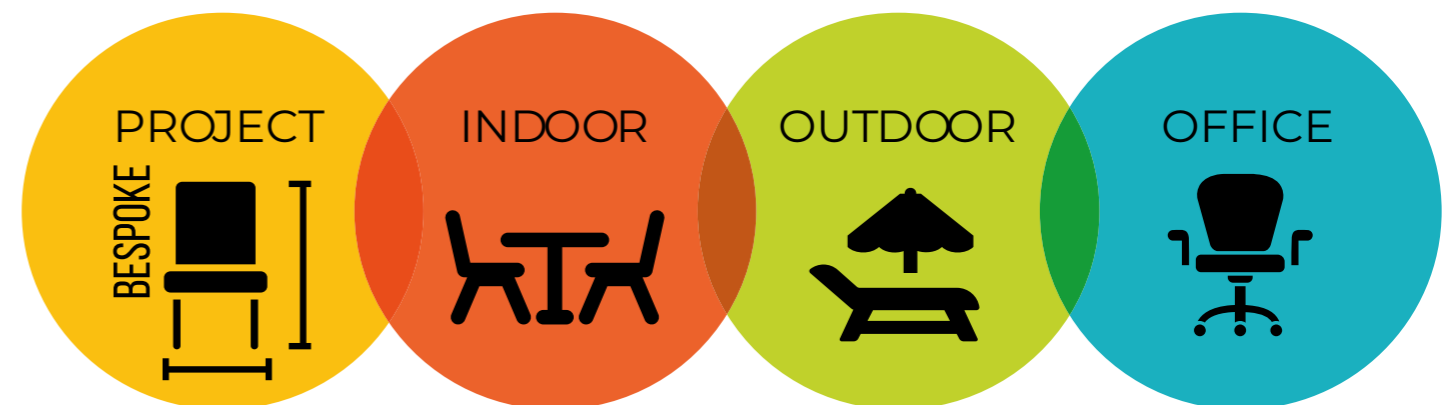

da pag. 28

da pag. 42

da pag. 186

da pag. 264

sgabelli da pag. 160

“UNA PICCOLA GRANDE STORIA DELLA BRIANZA”  
DAL 1993 AL VOSTRO SERVIZIO

# PL

Einrichtung Design  
S I N C E 1 9 9 9

Gastronomie & Eisbedarf GbR  
Rotherstr. 15  
90530 Wendelstein

Tel: +49 (0) 171 75 10 137 ( DE ) – Francesco Landolfo  
Tel: +39 371 13 81 840 ( IT ) – Francesco Landolfo  
Tel: +49 (0) 160 44 93 067 ( DE ) – Vincenzo Penna

info@gastronomie-eisbedarf.de  
www.gastronomie-eisbedarf.de





# I NUMERI CHE CONTANO

32.000 MT<sup>2</sup> DI UNITÀ OPERATIVE

**1.000.000 ARTICOLI IN PRONTA CONSEGNA**

CIRCA 400 TERZISTI / SUB-FORNITORI GESTITI

OLTRE 1.000 ARTICOLI EVASI AL GIORNO

CIRCA 30% FATTURATO EXPORT

# LA NOSTRA FORZA È LA PERSONALIZZAZIONE



TAPPEZZERIA PRODOTTI CUSTOM



UFFICIO COMMERCIALE  
18 addetti (Italia | Estero)



SPEDIZIONI



ASSEMBLAGGIO E QUALITY CONTROL

Azienda produttrice: LS Factory srl  
Serie: Hotel ..... (utilizzatore finale)  
Modello: **POLTRONCINA RISTORANTE**

VISTA FRONTALE



VISTA FRONTALE



PROGETTI OMOLOGATI



SPEDIZIONI



Art. 722 PANKA SOFT  
PRODOTTI A PROGETTO





Art. 1032 **Piatta** COD. 00129  
40x40-H72 verniciata nera  
per piani max 90x90



Art. 1032 **Piatta White** COD. 00129  
40x40-H72 verniciata bianca  
per piani max 90x90



Art. 1031 **Piramide** COD. 00129  
40x40-H72 verniciata nera  
per piani max 90x90

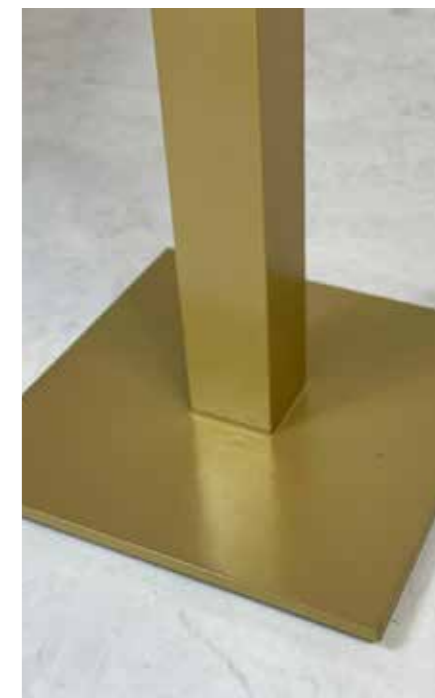

**NORMALMENTE IN PRONTA CONSEGNA**  
**PREZZI SPECIALI PER BANCALE 50 PZ., CONTATTARE UFFICIO COMMERCIALE**

piani clienti, schema di foratura G02 (piastra 300 x 300 mm)  
per basi: 1031 - 1032 - 1034 - 1037 - 1038 - 1046 LS **Como**

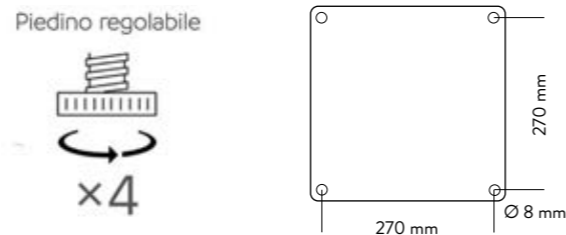

Art. 1034 **Piatta Snack**  
40x40-H108  
verniciata: **nera - bianca**  
per piani max 70x70



COD. 00159

**TAGLIO A MISURA  
IN ALTEZZA  
+ € 45,00 netti**



Art. 1037/D **Kuadra Double**  
(2 colonne 8x8) 75x40-H72 per piani max 140x90  
**verniciata nera** COD. 00260  
**inox lux** COD. 00270  
**inox satinato** COD. 00290



bronzo

antracite

oro

Mod. 1032 **Piatta CUSTOM**

ordine min. 10 pz. - tempi 20/30 gg

40x40-H72  
per piani max 90x90

COD. 00179

# BASI TONDE



Art. 641/5 **Max**

COD. 00430  
base Ø 70 - max piano Ø 130  
colori: **bianco - antracite**

Art. 643 **Island**

■ **BASE ACCIAIO VERNICIATA** bianca - solo base  
Ø 65 - H 71 COD. 00690  
■ **BASE ACCIAIO VERNICIATA** nera opaca - solo base  
Ø 65 - H 71 COD. 00760  
supplemento per sottopiano H3 cm nobilitato bianco COD. 0090  
per sofferire altezza tavolo

Art. 611 **Shai**

■ **BASE ACCIAIO VERNICIATA:** nera - bianca  
solo base Ø 69 - H 72,5 COD. 00590

**NORMALMENTE IN PRONTA CONSEGNA**



Base **Como** verniciata nera

Ø45-H73 Art. 1046.**LS45** COD. 00139  
per piani max Ø80 - 70x70

Ø54-H73 Art. 1046.**LS54** COD. 00168  
per piani max Ø100 - 80x80

Ø60-H73 Art. 1046.**LS60** COD. 00196  
per piani max Ø130

Base Art. 1046 **LSH**

**Como Snack** COD. 00158

**H108** Ø45 con piedini **nera**  
adatta anche per OUTDOOR  
per piani max 70x70

Piedino regolabile

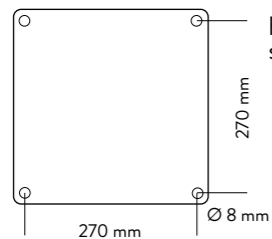

piani clienti,  
schema di foratura G02

**ACCESSORIO**  
**anello ottone H 10 cm**  
per **Base Como:**  
satinato + € 18,00  
lucido + € 24,00

per **Base Quadra:**  
satinato + € 23,00  
lucido + € 29,00

DISPONIBILE DA NOVEMBRE 23



Art. 1035 **Big Round**  
verniciata nera

COD. 00290

per piani max Ø180

DISPONIBILE DA  
NOVEMBRE 23

Piedino regolabile

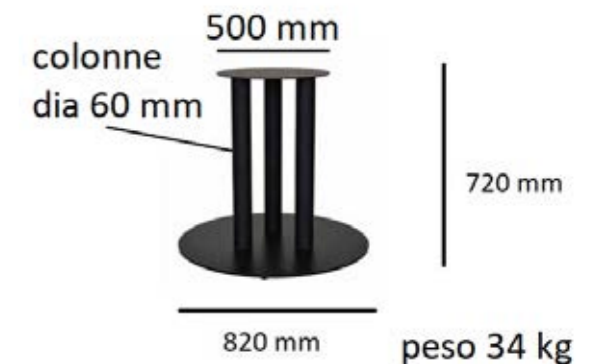

**NORMALMENTE  
IN PRONTA  
CONSEGNA**



Art. 1037/D **Kuadra Double**  
(2 colonne 8x8) 75x40-H72 per piani max 140x90

acciaio **inox lucido** COD. 00270  
acciaio **satinato** COD. 00290  
verniciata **nera** COD. 00260



Art. 1037 **Kuadra Lux**  
versione acciaio **inox lucido**  
40x40-H72 - tubo 8x8  
per piani max 90x90

COD. 00148



Art. 1037 **Kuadra Satinè**  
COD. 00148  
versione acciaio **satinato**  
40x40-H72 - tubo 8x8  
per piani max 90x90

Base Art. 1053 **Spritz**

**NORMALMENTE IN PRONTA CONSEGNA**

metallo verniciato **nero**

per piani max **70x70**  
uso **bar/gelateria**

NO ristorazione

COD. 00108



**BASI ACCIAIO** lucido o satinato

**NORMALMENTE IN PRONTA CONSEGNA**

Piedino regolabile



**Modello TORINO**

acciaio **satinato**

**H73** Art. 1036/1 COD. 00138  
**H108** Art. 1036/2 COD. 00157

Base Ø45 - Tubo 76 mm  
per piani max Ø80 - 70x70

piani clienti, schema di foratura G02

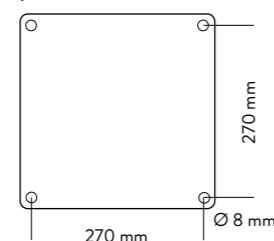

Art. 1037 HG **Kuadra High**  
COD. 00159  
acciaio **satinato**  
40x40-H108 - tubo 8x8  
per piani max 80x80

DISPONIBILE DA NOVEMBRE 23







## Art. 1779/..... Base Croce

Base a croce 55x55 in ghisa verniciata  
colonna quadra 5x5 in acciaio zincato  
Il tutto verniciato per esterno  
completo di piedini regolabili

disponibile nei colori: **bianco - antracite**

**H73** Art. 1779 /1 per piani max 80x80 COD. 00158

**H109** Art. 1779 /2 per piani max 70x70 COD. 00178

**NORMALMENTE IN PRONTA  
CONSEGNA**

Piedino regolabile



## Mod. Troll fissa

**NORMALMENTE  
IN PRONTA CONSEGNA**

**alluminio** verniciato **nero**  
con zavorra interna

**H73** Art. 1740/1 per piani max 80x80

COD. 00127

**H108** Art. 1740/2 per piani max 70x70

COD. 00139

piani clienti, schema di foratura G02

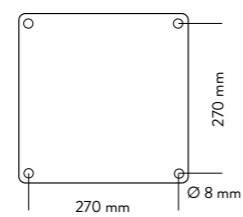

Piedino regolabile



Mod. Troll fissa

# BASI CLASSICHE



Art. 1052 **Impero**

43x43-H73 COD. 00163

- verniciata nera
- per piani max 90x90

- foratura non adatta per piani Art. 1049  
(usare n. 8 viti autofilettanti)

Art. 1043 **Bistrot**

43x43-H73 COD. 00163

- verniciata nera
- per piani max 90x90

- foratura non adatta per piani Art. 1049  
(usare n. 8 viti autofilettanti)



Piedino regolabile



**NORMALMENTE IN PRONTA CONSEGNA**

PIANI IN ESSENZA

ordine min. 10 pz.

con acconto - tempi 40/50 gg



Piano Art. 1059 **Rovere Contemporaneo**

SPESORE 4 CM, IMPIALLACCIATO ROVERE, FINITO A OLIO.  
**BORDO EFFETTO CORTECCIA DUE LATI**  
oppure DRITTO QUATTRO LATI

70x70 COD. 00380

80x80 COD. 00390

90x90 COD. 00390 solo bordo dritto

MISURE FISSE



# Piani Art. 1049 nobilitato **espressi** USO INDOOR

## **NORMALMENTE IN PRONTA CONSEGNA**

misure e colori tassativamente fissi (no costo gestione) CONSEGNA SU BANCALE REGGIATO

colori non compatibili con Art. 1060/1061 i su misura

**foratura bussole solo per basi:** Art. 1031 - 1032 - 1034 - 1037 - 1038 - 1046.LS45/54/60

Per altre basi: applicazione bussole antistrappo (con vite brugola) + € 8,00 netti

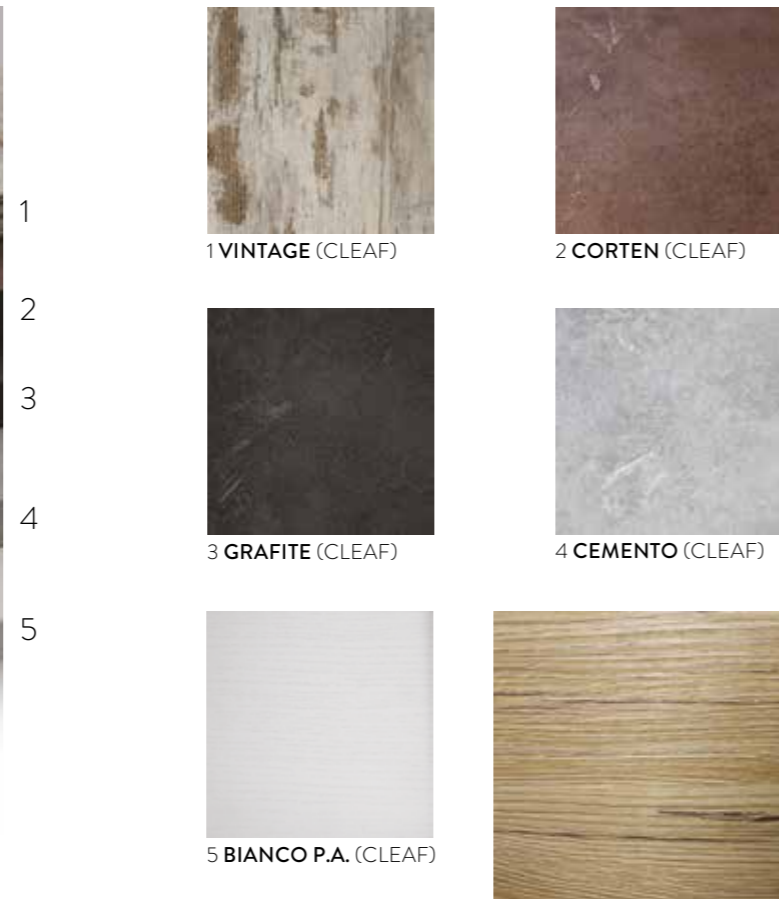

NOBILITATO / BORDO ABS:  spessore 25 mm

dimensione **67x67** COD. 0098

dimensione **80x80** COD. 00127

I nostri piani hanno incluse bussole antistrappo con viti 6MA 

### Art. 1050 **GPR GANCI PER PROLUNGA** per basamento centrale

COD. 0016 cad. Gancio per prolungha, con gancio si intende maschio / femmina (set 4 ganci per singola prolungha COD. 0064)

**solo per piani 25 mm** Art. 1049 da aggiungere costo (non applicabili su piani 50 mm, e stratificati)

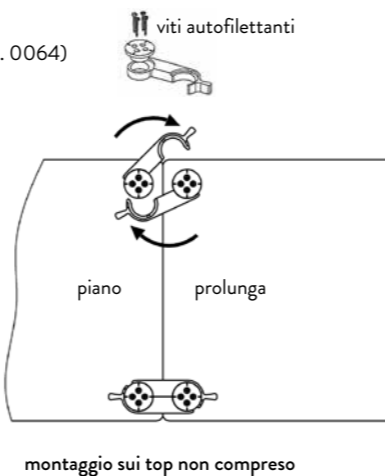
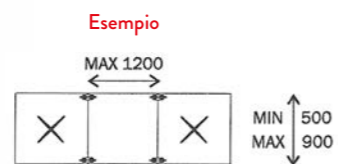

# Piani contract nobilitato **"i su misura"** Art. 1060-1061 per interni - colori non compatibili con Art. 1049 espressi

■ **TEMPI 20/30 GG** - CONSEGNA SU BANCALE REGGIATO

■ **COSTI GESTIONE TECNICA, ORDINI SOTTO:**

5 PIANI + € 40,00 NETTI - 10 PIANI + € 30,00 NETTI - 15 PIANI + € 20,00 NETTI - OLTRE 20 PIANI NESSUN SUPPLEMENTO

NB: PER QUESTO TIPO DI PIANI VERRÀ CHIESTO UN ACCONTO PER LA MESSA IN PRODUZIONE



 **25 mm** - Art. 1060



 **50 mm** - Art. 1061

	nobilitato bordo ABS: <b>bianco liscio</b>	nobilitato special bordo ABS in tinta: <b>colori speciali</b> vedi sopra	nobilitato bordo ABS in tinta: <b>bianco liscio</b>	nobilitato special bordo ABS in tinta: <b>colori speciali</b> vedi sopra
■ 60 x 60	COD. 0066	COD. 0084	COD. 00100	COD. 00112
■ 70 x 70	COD. 0074	COD. 00104	COD. 00116	COD. 00132
■ 80 x 80	COD. 0096	COD. 00139	COD. 00142	COD. 00182
■ 90 x 90	COD. 00116	COD. 00159	COD. 00176	COD. 00207
■ 120 x 80	COD. 00143	COD. 00188	COD. 00198	COD. 00209
■ 140 x 80	COD. 00164	COD. 00212	COD. 00232	COD. 00244
■ 160 x 80	COD. 00186	COD. 00264	COD. 00282	COD. 00308
■ Ø 60	COD. 0088	COD. 00108	COD. 00126	COD. 00136
■ Ø 70	COD. 0097	COD. 00129	COD. 00144	COD. 00162
■ Ø 80	COD. 00126	COD. 00169	COD. 00168	COD. 00208
■ Ø 90	COD. 00146	COD. 00189	COD. 00212	COD. 00234
■ Ø 100	COD. 00189	COD. 00228	-	-
■ Ø 110	COD. 00228	COD. 00276	-	-
■ Ø 120	COD. 00267	COD. 00327	-	-

A RICHIESTA ANCHE SU MISURA: commerciale@laseggiola.it  
Per questo tipo di prodotto verrà richiesto tassativamente acconto

I nostri piani hanno incluse bussole antistrappo con viti 6MA 

Piani Art. 1051 **HPL stratificato espressi** INDOOR / OUTDOOR

 spessore 10 mm, bordo dritto, con attacco universale

**misure e colori tassativamente fissi** (no costo gestione) CONSEGNA SU BANCALE REGGIATO

**Sistema di fissaggio universale**  
Possibilità di applicazione a tutte le basi

VITERIA SPECIALE INCLUSA

colori non compatibili con Art. 1058 i su misura

**NORMALMENTE IN PRONTA CONSEGNA**  
NO COSTO GESTIONE

DALLE MISURE INDICATE MANCA 1 CM PER LATO

**IMPORTANTE:**  
I COLORI SCURI VANNO TENUTI IN ZONE OMBREGGiate (L'ASSORBIMENTO DEI RAGGI UVA ACCUMULA CALORE E TENDONO A STORTARSI)

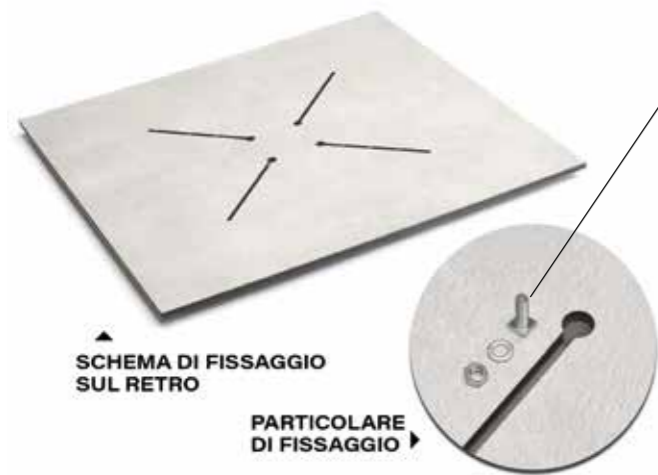

SCHEMA DI FISSAGGIO SUL RETRO

PARTICOLARE DI FISSAGGIO



**rovere nodato MAH**  
70x70 COD. 00184\* - 00168\*\* - 00149\*\*\*  
80x80 COD. 00209\* - 00189\*\* - 00173\*\*\*

**corten CRT**  
70x70 COD. 00184\* - 00168\*\* - 00149\*\*\*  
80x80 COD. 00209\* - 00189\*\* - 00173\*\*\*

**marmo nero THT**  
70x70 COD. 00184\* - 00168\*\* - 00149\*\*\*  
80x80 COD. 00209\* - 00189\*\* - 00173\*\*\*

\* ORDINI DA 1 A 9 PZ. | \*\* ORDINI DA 10 A 19 PZ. | \*\*\* ORDINI OLTRE 20 PZ.



**cemento CMT**  
70x70 COD. 00184\* - 00168\*\* - 00149\*\*\*  
80x80 COD. 00209\* - 00189\*\* - 00173\*\*\*

**marmo bianco BLI**  
70x70 COD. 00199\* - 00177\*\* - 00158\*\*\*  
80x80 COD. 00228\* - 00196\*\* - 00179\*\*\*

**bianco BNC (corpo nero)**  
70x70 COD. 00168\* - 00149\*\* - 00139\*\*\*  
80x80 COD. 00196\* - 00176\*\* - 00163\*\*\*

Piani contract Art. 1058 **HPL stratificato "i su misura"**

per interni / **esterni**  spessore 10 mm, bordo dritto

colori non compatibili con Art. 1051 espressi



**BIANCO \***  
(001 FIN. R. corpo nero)



**MARMO BIANCO LISCIO \*\***  
(5547 FIN. OPACA corpo nero)



**PIETRA CHIARA \*\***  
(6075 FIN. PLAMKY corpo nero)



**PIETRA SCURA \*\***  
(6076 FIN. PLAMKY corpo nero)



**ARDESIA FIN. PIETRA \*\***  
(3349 FIN. LUNA corpo nero)



**CEMENTO FIN. PIETRA \*\***  
(3192 FIN. LUNA corpo nero)



**CORTEN \*\***  
(3276 FIN. LUNA corpo marrone)



**ROVERE NATURALE \*\*\***  
(4543 FIN. ALEVE corpo marrone)

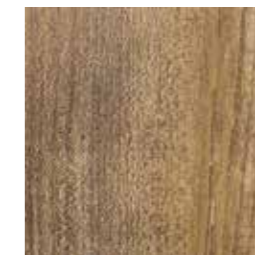

**ROVERE SLAVONIA \*\*\***  
(4587 FIN. ALEVE corpo marrone)



**MARMO SCURO LUCIDO \*\*\***  
(6086 LUCIDO corpo nero)

■ **TEMPI 25/40 GG** - CONSEGNA SU BANCALE REGGIATO

■ **COSTI GESTIONE TECNICA, ORDINI SOTTO:**  
5 PIANI + € 40,00 NETTI - 10 PIANI + € 30,00 NETTI - OLTRE 10 PIANI NESSUN SUPPLEMENTO

NB: PER QUESTO TIPO DI PIANI VERRÀ CHIESTO UN ACCONTO PER LA MESSA IN PRODUZIONE

DIMENSIONI:

60x60 - Ø 60	* COD. 00112	** COD. 00120	*** COD. 00142
70x70 - Ø 70	* COD. 00168	** COD. 00178	*** COD. 00188
80x80 - Ø 80	* COD. 00196	** COD. 00204	*** COD. 00232
90x90 - Ø 90	* COD. 00239	** COD. 00276	*** COD. 00288
Ø 100	* COD. 00312	** COD. 00348	*** COD. 00376
Ø 120	* COD. 00464	** COD. 00519	*** COD. 00598
Ø 130	* COD. 00528	** COD. 00552	*** COD. 00629
120x80	* COD. 00312	** COD. 00342	*** COD. 00379
140x80	* COD. 00328	** COD. 00384	*** COD. 00386
160x80	* COD. 00392	** COD. 00432	*** COD. 00434

DALLE MISURE INDICATE MANCA 1 CM PER LATO RAGGIO ANGOLI 10 MM.

**IMPORTANTE:**  
I COLORI SCURI VANNO TENUTI IN ZONE OMBREGGiate (L'ASSORBIMENTO DEI RAGGI UVA ACCUMULA CALORE E TENDONO A STORTARSI)

A RICHIESTA ANCHE SU MISURA: [commerciale@laseggiola.it](mailto:commerciale@laseggiola.it)  
Per questo tipo di prodotto verrà richiesto tassativamente acconto

I nostri piani hanno incluse bussole antistrappo con viti 6MA



**A RICHIESTA FRESATURA PER VITI ATTACCO UNIVERSALE**  
+ € 18,00 A PIANO (INCLUSO VITI SPECIALI)  
OBBLIGATORIO PER BASE CLIENTE e Art. 1052 Impero

# i LUXURY TOP

lucidi, resistenti, **non assorbono.....** e glamour

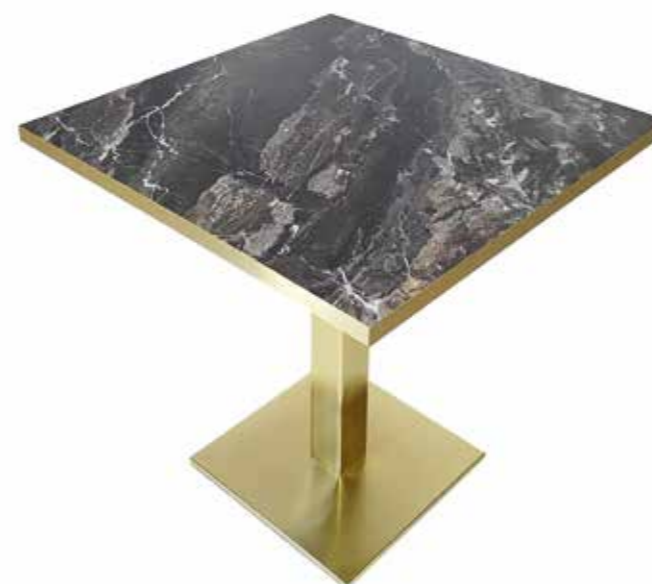

**MARMO SCURO LUCIDO** - PRINT 1456 FIN. LUCIDO



**MARMO CHIARO LUCIDO** - PRINT 1459 FIN. LUCIDO

■ Base **Piatta Ottonata**

**effetto satinato opaco** COD. 00326  
verniciatura a liquido (vedi pag. 189 Base Como)  
40x40-H73 **tubo 5x5** - per piani max 90x90

H 109 snack COD. 00388 - per piani max 70x70  
ORDINE SOTTO 5 PZ + € 50,00 per gestione - TEMPI 20/25 GG.

**bagno galvanico satinato** COD. 00360  
come foto  
40x40-H73 **tubo 8x8** - per piani max 90x90

H 109 snack COD. 00420 - per piani max 70x70  
ORDINE MINIMO 10 PZ TAX - TEMPI 50/60 GG.

## Top 1102 **Marmo Lux**

■ **PIANO LAMINATO HPL LUCIDO** CONTROPLACCATO  
bordo ABS **ottone satinato**

## Top 1050/29 **Vitrum**

■ **PIANO VETRO RETROLACCATO**

accoppiato con nobilitato, spessore totale 30 mm, bordo ABS antiurto

BORDO: ottone lucido o satinato

■ QUADRATO:	<b>bianco-nero</b>	<b>RAL</b> (ordine min. 10 pz. TAX)
60 x 60	COD. 00240	COD. 00290
70 x 70	COD. 00260	COD. 00330
80 x 80	COD. 00290	COD. 00395
90 x 90	COD. 00330	COD. 00440

■ TONDO o QUADRO CON ANGOLI RAGGIO 50 mm		
Ø 60 - 60 x 60	COD. 00260	COD. 00320
Ø 70 - 70 x 70	COD. 00280	COD. 00390
Ø 80 - 80 x 80	COD. 00310	COD. 00470
Ø 90 - 90 x 90	COD. 00360	COD. 00490
Ø 100	COD. 00670	-
Ø 110	COD. 00770	-
Ø 120	COD. 00890	-

SOTTO 10 PZ. GESTIONE TECNICA € 45,00 netti - TEMPI 40 GG

**misure particolari a richiesta**

**NB: PER LA MESSA IN PRODUZIONE  
NECESSITA ACCONTO**



**include** bussole antistrappo  
con viti 6MA



 **spessore 30 mm**

■ **QUADRATO**

60 x 60	COD. 0092
70 x 70	COD. 00124
80 x 80	COD. 00144
90 x 90	COD. 00172
120 x 80	COD. 00196

■ **TONDO o QUADRO CON ANGOLI RAGGIO 50 mm**

Ø 60	COD. 00124
Ø 70	COD. 00153
Ø 80	COD. 00184
Ø 90	COD. 00236

DALLE MISURE INDICATE MANCA 1 CM PER LATO

■ **COSTI GESTIONE TECNICA,**  
ORDINI SOTTO:  
5 PIANI + € 30,00 NETTI  
10 PIANI + € 20,00 NETTI  
OLTRE 10 PIANI NESSUN SUPPLEMENTO

**NB: PER LA MESSA IN PRODUZIONE  
NECESSITA ACCONTO**

 **spessore 50 mm**

■ **QUADRATO**

60 x 60	COD. 00126
70 x 70	COD. 00158
80 x 80	COD. 00176
90 x 90	COD. 00214
120 x 80	COD. 00248

■ **TONDO**

Ø 60	COD. 00148
Ø 70	COD. 00186
Ø 80	COD. 00216
Ø 90	COD. 00256

■ **TEMPI 25/30 GG**  
CONSEGNA SU BANCALE REGGIATO



**include** bussole antistrappo  
con viti 6MA



## il tavolo al centimetro...

### Art. 663 Kerwin

- **NORMALMENTE IN PRONTA CONSEGNA**, solo struttura misure di serie - \*taglio struttura misura + 70,00 netti (LE STRUTTURE SONO PIÙ CORTE DI 1 CM PER LATO, TEMPI 30 GG)

adatto per piani in marmo, agglomerati, ecc. (non adatto per piani vetro trasparente)

MISURE: SEZIONE GAMBA 4 X 4	80 x 80 90 x 90	120 x 70	120 x 80	140 x 80	160 x 90	180 x 90
■ COMPLETO DI PIANO NOBILITATO 20 mm bianco - H 75	COD. 00445	COD. 00480	COD. 00495	COD. 00520	COD. 00560	COD. 00590
■ *solo struttura PIANO CLIENTE - H 73						
■ VERNICIATA alluminio	COD. 00320	COD. 00330	COD. 00340	COD. 00360	COD. 00380	COD. 00395
■ VERNICIATA bianca	COD. 00320	COD. 00330	COD. 00340	COD. 00360	COD. 00380	COD. 00395
■ VERNICIATA antracite	COD. 00320	COD. 00330	COD. 00340	COD. 00360	COD. 00380	COD. 00395



## NUOVA VERSIONE H110 + COD. 0090

solo verniciata: bianca e antracite



particolare giunto brevettato

# PROGRAMMA PANKA SOFT

TOTALMENTE PRODOTTE INTERNAMENTE  
ANCHE SU MISURA

TEMPI 40/50 GG  
CON ACCONTO



## Art. 722/3 Panka base terra **Bottoni**

spessore cuscino 20 cm / BASE SAGOMATA

<b>H101 - P62</b>	<b>L120</b>	<b>L140</b>
con tessuto	COD. 001530	COD. 001710
tessuto cliente	COD. 001320 (3,5 mt)	COD. 001430 (4,5 mt)

### ELEMENTO ANGOLARE 62x62

con tessuto	COD. 001790	COD. 001990
tessuto cliente	COD. 001560 (3,5 mt)	COD. 001650 (4,2 mt)

composizione angolare, in fase d'ordine inviare la disposizione in pianta

Tessuto: **ecopelle - velluto** (retro rivestito, finito a vista)  
CAT B - pag. 252 - VOL.1

**GOMMA IGNIFUGA / ECOPELLE IGNIFUGA +15%**  
**GOMMA IGNIFUGA / VELLUTO IGNIFUGO +20%**

Base nobilitato



bianco antracite nero



## Tavolo Art. 721/T **Fratino Restile**

- BASE: acciaio satinato - inox lucido
- PIANO spessore 50 mm
- COLORI vedi piani Art. 1061 pag. 195

MISURE: 120 x 80	COD. 00640
MISURE: 140 x 80	COD. 00680



schienale **MODULI**  
(da grande a piccolo a salire)



schienale **STRISCE VERTICALI**



schienale **STRISCE ORIZZONTALI**

supplemento per  
spessore cuscino 20 cm  
**L120 + € 160,00**  
**L140 + € 180,00**  
**ANGOLO + € 190,00**

## Panka base terra

### Art. 722/1 SCHIENALE LISCIO spessore cuscino 20 cm / BASE SAGOMATA

<b>H101 - P62</b>	
<b>L120</b>	COD. 001420
<b>L140</b>	COD. 001580
<b>ANGOLO</b>	COD. 001710

composizione angolare,  
in fase d'ordine inviare la disposizione in pianta

### Art. 722/5 SCHIENALE: CUBI / MODULI / STRISCE spessore cuscino 10 cm / BASE DRITTA

<b>H109 - P62</b>	
<b>L120</b>	COD. 001310
<b>L140</b>	COD. 001430
<b>ANGOLO</b>	COD. 001580

<b>H138 - P62</b>	
<b>L120</b>	COD. 001470
<b>L140</b>	COD. 001560
<b>ANGOLO</b>	COD. 001720



RETRO RIVESTITO, FINITO A VISTA



Art. 722/1 schienale liscio  
spessore cuscino 20 cm / BASE SAGOMATA



schienale  
**CUBI**

Art. 722/5 schienale: cubi / moduli / strisce,  
spessore cuscino 10 cm / BASE DRITTA



base foto non disponibile, vedi Art. 1053 Spritz



Brill

Bottoni



a muro oppure  
panca contro panca

### Art. 722/6 Panka Base piedini

P60 - Tessuto: **ecopelle** - velluto - retro rivestito, finito a vista

<b>H109</b>	L120	L140
Bottoni	COD. 001450	COD. 001600
Brill	COD. 001630	COD. 001820

<b>H138</b>	L120	L140
Bottoni	COD. 001590	COD. 001740
Brill	COD. 001780	COD. 001960

**ELEMENTO ANGOLARE 60x60**

Bottoni	COD. 001830	COD. 002020
Brill	COD. 002060	COD. 002380

composizione angolare, in fase d'ordine inviare la disposizione in pianta



### Art. 720 Panka Young

L120 - P56 - HS48 - HT85 - ORDINE MINIMO 4 PZ. - TEMPI 40 GG

- METALLO VERNICIATO: **bianco - nero**
- STOFFE CATEGORIA B COD. 00590
- STOFFA CLIENTE (2 MT) COD. 00540
- SUPPLEMENTO PER GOMMA IGNIFUGA **40,00**



### 1085/5 Discoteque POLTRONCINA PER LOCALE PUBBLICO STRUTTURA IN POLIURETANO IGNIFUGO RIVESTITA ECOPELLE

elemento poltrona STE.1 (stoffa cliente 1,7 mt - € 395,00)	<b>520,00</b>
elemento divano 2 posti STE.2 (stoffa cliente 3,4 mt - € 620,00)	<b>845,00</b>
elemento spicchio angolo 45° circolare chiuso STE.AC (stoffa cliente 1,7 mt - € 430,00)	<b>545,00</b>
elemento angolo 90° quadro chiuso STE.AQ (stoffa cliente 3,4 mt - € 650,00)	<b>880,00</b>
elemento angolo 90° aperto senza schienale STE.AA (stoffa cliente 1,5 mt - € 395,00)	<b>520,00</b>
elemento angolo 90° aperto con schienale STE.AASCH (stoffa cliente 1,8 mt - € 440,00)	<b>585,00</b>

Ordine minimo 12 elementi anche misti - tempi 40/50 gg

PRODOTTO IN POLIURETANO IGNIFUGO CERTIFICATO CLASSE 1M

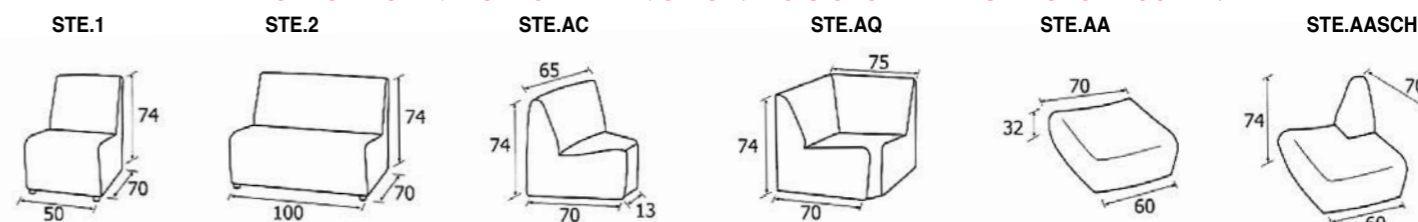





## Art. 807 Cilindro

- **IMBALLO N. 1 pz.**
- **TEMPI 15/25 GG.**
- **POUF BASE NOBILITATO / BORDO ABS OTTONE**  
PARTE INTERNA POLISTIROLO ALTA DENSITÀ RIVESTITO IN VELLUTO:  
**beige - tortora - grigio fumo - ottanio**  
**verde - giallo - mattone - rosa antico**      COD. 00176
- stoffa cliente (1 mt.)**      COD. 00161

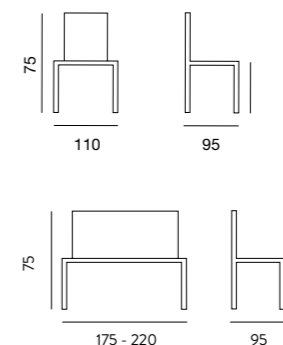
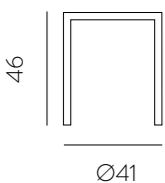

## Art. 430 Regency

- **POLTRONA**  
**CAT. B**      COD. 002280  
**stoffa cliente**      COD. 001980  
**STOFFA 7 ML - PELLE 10 MQ**
- **DIVANO 2 POSTI**  
**CAT. B**      COD. 002980  
**stoffa cliente**      COD. 002590  
**STOFFA 10 ML - PELLE 15 MQ**
- **DIVANO 3 POSTI**  
**CAT. B**      COD. 003570  
**stoffa cliente**      COD. 003090  
**STOFFA 12 ML - PELLE 17 MQ**



- **TEMPI 40/50 GG. (da ricevimento acconto)**

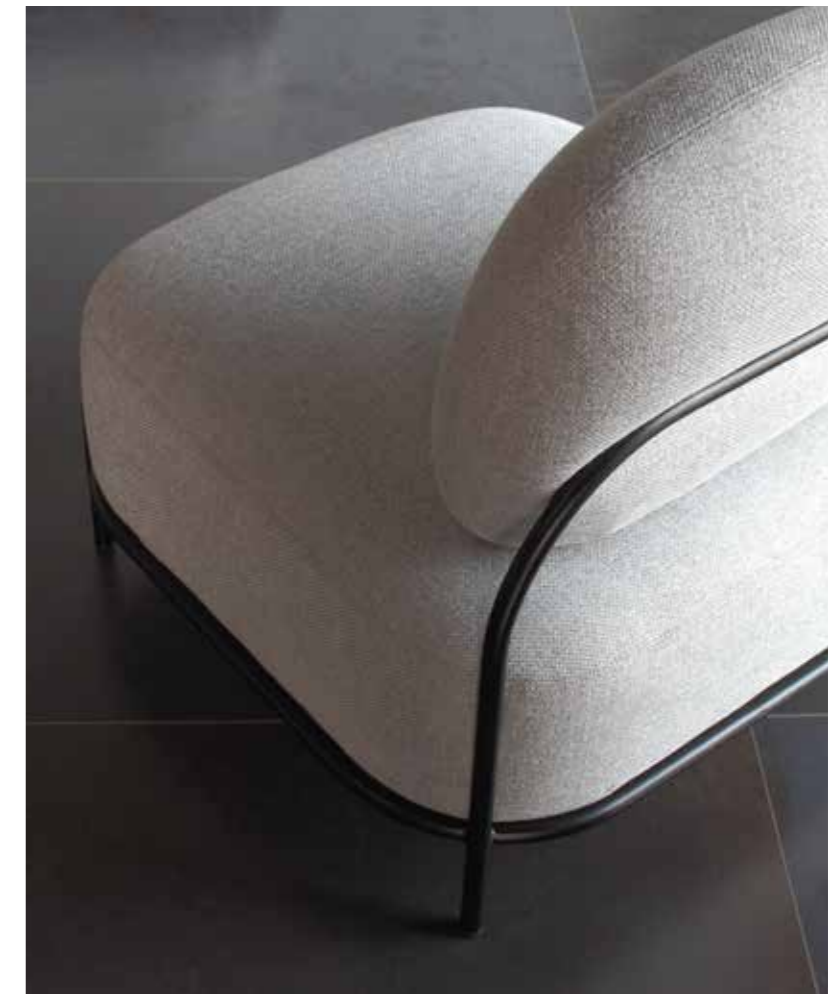

## modello Larking

struttura nera / **tessuto grigio**

■ **NORMALMENTE IN PRONTA CONSEGNA**

**divanetto Art. 398/2** 125x72xH78 - HS40

COD. 00786 tessuto grigio di serie  
stoffa cliente (3 MT) COD. 001186 - custom cat.B COD. 001298

**poltrona Art. 398/1** 67x72xH77 - HS40

COD. 00490 tessuto grigio di serie  
stoffa cliente (2 MT) COD. 00990 - custom cat.B COD. 001070

**pouf Art. 398/3** 42x42xH47  
disponibile da marzo 2024

COD. 00190 tessuto grigio di serie  
stoffa cliente (1,5 MT) COD. 00430 - custom cat.B COD. 00490





## Art. 386 Juliette Lounge

- **ORDINE MINIMO 4 PZ. - TEMPI 40 GG**
- VELLUTO NON IGNIFUGO COD. 00580
- STOFFA CLIENTE (1,8 MT) COD. 00520
  
- SUPPLEMENTO PER GOMMA IGNIFUGA **+ 15,00**  
Velluto ignifugo **+ € 50,00** (ordine min. 10 pz.)
  
- **STRUTTURA VERNICIATA nera**

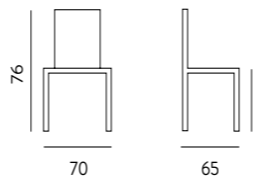

## Art. 385 Jorgette

poltrona lounge

stoffa CAT. B COD. 001130  
stoffa cliente (3 mt) COD. 001090

**TEMPI 30 gg.**

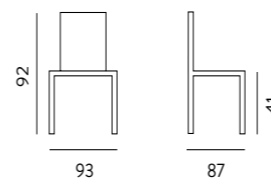



## Art. 394 Candy

- IMBALLO N. 1 pz.
- **NORMALMENTE IN PRONTA CONSEGNA**
- GAMBE MASSELLO DI FAGGIO TINTO NATURALE  
STRUTTURA POLIPROPILENE

- PP **BIANCO** / TESSUTO **GRIGIO** COD. 00398
- PP **GRIGIO** / TESSUTO **GRIGIO** COD. 00398
- PP **CELESTE** / TESSUTO **CELESTE** COD. 00398
- stoffa cliente (1,2 MT) COD. 00558 - custom cat.B COD. 00638

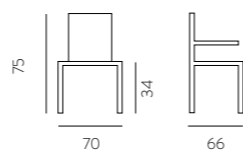

## Art. 396 Candy pouf

- IMBALLO N. 1 pz.
- **NORMALMENTE IN PRONTA CONSEGNA**
- GAMBE MASSELLO DI FAGGIO TINTO NATURALE

- TESSUTO **GRIGIO** COD. 00189
- TESSUTO **CELESTE** COD. 00189
- stoffa cliente (0,8 MT) COD. 00229 - custom cat.B COD. 00259





## Art. 390 Gretel

- **IMBALLO N. 2 pz.**  
Imballo speciale 1 pz. + 10,00 netto
- **NORMALMENTE IN PRONTA CONSEGNA**
- **STRUTTURA METALLO CROMATO**
- **SCOCCA IN POLIPROPILENE BIANCO**
- **CUSCINO SFODERABILE SINTETICO SOFT grigio**

COD. 00480

**CUSTOM**  
stoffa cliente  
mt. 2 cad.

tessuto cat. B  
ECOPELLE - VELLUTO

COD. 00586

COD. 00658

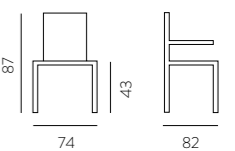

**ALTRI LOUNGE / SOFÀ  
CONTRACT / OFFICE**  
vedi da pag. 272



## Art. 304 Lulù

■ **IMBALLO N. 4 pz.**

Imballo speciale 1/3 pz. + 10,00 netto

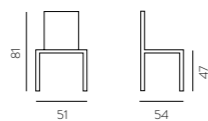

■ **NORMALMENTE IN PRONTA CONSEGNA**

■ **VELLUTO:**

antracite - grigio perla - verde bosco - rosa cipria - tortora

**COLORI NEWS:** mattone - ottanio

■ **GAMBE VERNICIATE NERE**

COD. 00166

■ **GAMBE OTTONE LUCIDO galvanico**

COD. 00178

gamba Ø 22 conificata



### CUSTOM

stoffa cliente + COD. 0052  
mt. 1,2 cad.

tessuto cat. B + COD. 0084  
ECOPELLE - VELLUTO

Art. 506/8

Supplemento gomma ignifuga + € 15,00 / supplemento velluto ignifugo + € 20,00  
NB: ordine minimo 20 pz.



cucitura con PIPING



antracite



grigio perla



rosa cipria



verde bosco



tortora



NEWS



ottanio



mattone

Il velluto potrebbe presentare effetti che non sono da considerare difettosità in quanto caratteristiche della composizione e del tipo di lavorazione: effetto a macchia o marazzatura, effetto chiaro/scuro, effetto impronta



## Art. 306 **Musa**

- **IMBALLO N. 4 pz.**

Imballo speciale 1/3 pz. + 10,00 netto

- **NORMALMENTE IN PRONTA CONSEGNA**

- **VELLUTO:**

antracite - verde bosco - rosa cipria

- **GAMBE VERNICIATE NERE**

COD. 00159

gamba Ø 25 conificata

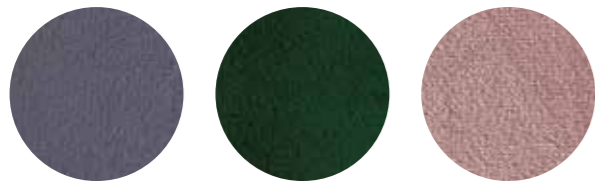

antracite

verde bosco

rosa cipria

Il velluto potrebbe presentare effetti che non sono da considerare difettosità in quanto caratteristiche della composizione e del tipo di lavorazione: effetto a macchia o marazzatura, effetto chiaro/scuro, effetto impronta

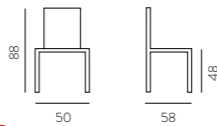

## Art. 305 **Cocò**

- **IMBALLO N. 4 pz.**

Imballo speciale 1/3 pz. + 10,00 netto

- **NORMALMENTE IN PRONTA CONSEGNA**

- **STRUTTURA METALLO VERNICIATA NERA**

- **VELLUTO ANTIMACCHIA:**

nero / **puntale** verniciato **ottone**

nero / gambe **tutte nere**

antracite / **puntale** verniciato **silver**

verde bosco / gambe **tutte nere**



COD. 00116

COD. 00116

COD. 00116

COD. 00116

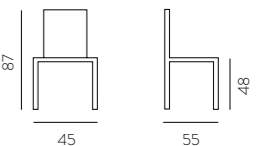

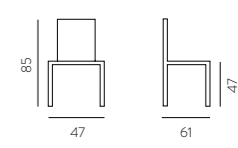
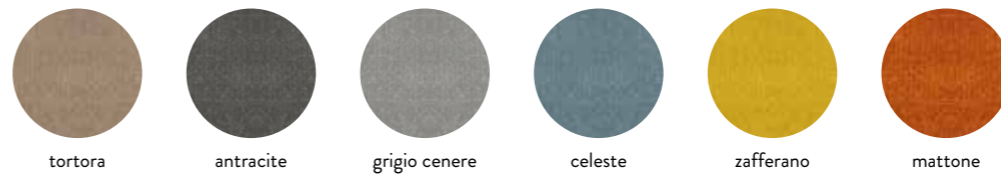

Il velluto potrebbe presentare effetti che non sono da considerare difettosità in quanto caratteristiche della composizione e del tipo di lavorazione: effetto a macchia o marzatura, effetto chiaro/scuro, effetto impronta

Art. 206 **Zara**

■ **IMBALLO N. 4 pz.**  
Imballo speciale 1/3 pz. + 10,00 netto

- **NORMALMENTE IN PRONTA CONSEGNA**
- **STRUTTURA METALLO VERNICIATA NERA**
- **VELLUTO ANTIMACCHIA:**  
tortora - antracite - grigio cenere  
celeste - zafferano - mattone

COD. 00198

**CUSTOM**  
stoffa cliente  
mt. 1.5 cad.

COD. 00218

tessuto cat. **B**  
ECOPELLE - VELLUTO

COD. 00250

Supplemento gomma ignifuga + € 15,00  
Supplemento velluto ignifugo + € 20,00  
NB: ordine minimo 20 pz.







582 Juliette Stool

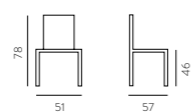

## Art. 382 Juliette

- **IMBALLO N. 2 pz.**
- **NORMALMENTE IN PRONTA CONSEGNA**
- **STRUTTURA METALLO VERNICIATA NERO LAMBORGHINI**      **COD. 00228**
- **VELLUTO ANTIMACCHIA:**  
 grigio fumo - celeste - rosa - verde - ottanio - mattone - giallo  
 stoffa cliente min 20 pz.

Il velluto potrebbe presentare effetti che non sono da considerare difettosità in quanto caratteristiche della composizione e del tipo di lavorazione: effetto a macchia o marazzatura, effetto chiaro/scuro, effetto impronta



## Art. 217 Ginger

- **IMBALLO N. 2 pz.**  
Imballo speciale 1 pz. + 10,00 netto

- **NORMALMENTE IN PRONTA CONSEGNA**

- **NERO/VELLUTO\*** COD. 00194  
accessorio piedino ottone H 8 cm + € 36,00 set 4 pz.

- **OTTONE/VELLUTO\*** COD. 00268  
ottone lucido a bagno galvanico "MADE IN ITALY"

\* **VELLUTO** di serie:  
grigio fumo - tortora - senape - arancio - blu - verde  
stoffa cliente min 20 pz.

Supplemento gomma ignifuga + € 15,00  
Supplemento velluto ignifugo + € 20,00  
NB: ordine minimo 20 pz.

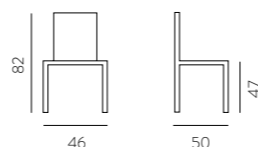

accessorio  
piedino ottone



### ACCESSORIO per basi anello ottone H 10 cm

per **Base Como:**  
satinato + € 18,00  
lucido + € 24,00

per **Base Quadra:**  
satinato + € 23,00  
lucido + € 29,00



517/8 Ginger Stool



## Art. 208 Opera

- **IMBALLO N. 4 pz.** Imballo speciale 1/3 pz. + 10,00 netto
- **NORMALMENTE IN PRONTA CONSEGNA**

- **STRUTTURA METALLO VERNICIATA NERA / PIEDINO OTTONE SATINATO**
- **VELLUTO ANTIMACCHIA:**  
sabbia - grigio fumo

COD. 00246

cucitura con PIPING

## CUSTOM

stoffa cliente COD. 00320

mt. 1,5 cad. da valutare se tessuto  
è adatto per questo tipo di sedia

tessuto cat. B COD. 00360  
VELLUTO

Supplemento gomma ignifuga + € 15,00  
Supplemento velluto ignifugo + € 20,00  
NB: ordine minimo 20 pz.

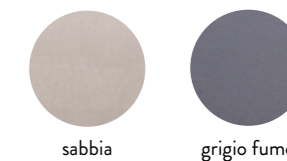
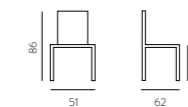

Il velluto potrebbe presentare effetti che non sono da considerare difettosità in quanto caratteristiche della composizione e del tipo di lavorazione: effetto a macchia o marazzatura, effetto chiaro/scuro, effetto impronta





NEWS  
OPERA STOOL  
vedi settore sgabelli

ACCESSORIO per basi  
anello ottone H 10 cm  
per Base Como:  
satinato + € 18,00  
lucido + € 24,00  
per Base Quadra:  
satinato + € 23,00  
lucido + € 29,00





## Art. 209 Barcellona

- **IMBALLO N. 2 pz.**  
Imballo speciale 1 pz. + 10,00 netto
- **NORMALMENTE IN PRONTA CONSEGNA**
- **STRUTTURA METALLO VERNICIATA NERA**
- **ECOPELLE:**  
**ottanio - titanio** COD. 00238
- **VELLUTO ANTIMACCHIA:**  
**sabbia - grigio fumo - verde** COD. 00238

Il velluto potrebbe presentare effetti che non sono da considerare difettosità in quanto caratteristiche della composizione e del tipo di lavorazione:  
effetto a macchia o marazzatura, effetto chiaro/scuro, effetto impronta



**CUSTOM**  
**stoffa cliente** + COD. 0072  
 mt. 1,4 cad.  
**tessuto cat. B** + COD. 00107  
 ECOPELLE - VELLUTO

Supplemento velluto ignifugo + € 20,00  
 NB: ordine minimo 20 pz.

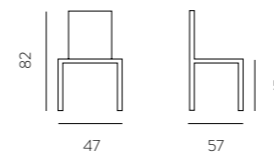



## Art. 100 Roma

- IMBALLO N. 2 pz.
- **NORMALMENTE IN PRONTA CONSEGNA**
- BASE 4 GAMBE VERNICIATA NERA
- ECOPELLE, SEDILE LISCIA / SCHIENALE STAMPATO A RILIEVO:

tortora chiaro - nocciola - titanio

COD. 00248

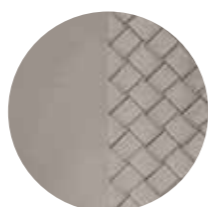
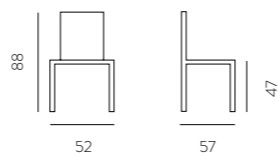

tortora chiaro



nocciola



grigio titanio





## Art. 379 Pigalle Uno CASA

QUESTA VERSIONE SOLO CON TESSUTO DI SERIE, CUSTOM VEDI ART. 380 pag. dopo

- IMBALLO N. 2 pz.  
Imballo speciale 1 pz. + 10,00 netto

■ **NORMALMENTE IN PRONTA CONSEGNA**

■ STRUTTURA METALLO VERNICIATA **NERA**

■ VELLUTO ANTIMACCHIA:

tortora - antracite - verde

COD. 00246

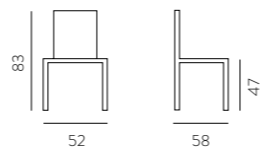

tortora

antracite

verde

Il velluto potrebbe presentare effetti che non sono da considerare difettosità in quanto caratteristiche della composizione e del tipo di lavorazione: effetto a macchia o marazzatura, effetto chiaro/scuro, effetto impronta





VELLUTO SCHIENALE TRAPUNTATO  
COD. 00320 ordine min. 12 pz.

## semipoltroncina Art. 380 Pigalle Uno CUSTOM

- TEMPI 30 GG.
- GAMBE METALLO VERNICIATA: NERA - SUPPLEMENTO BRONZO + € 12,00
- Velluto: giallo - mattone - rosa - ottanio - verde
- Tessuto bouclé - ecopelle VARI COLORI
- Stoffa cliente (1,5 mt)
- Supplemento gomma ignifuga + € 15,00 / supplemento velluto ignifugo + € 20,00 NB: ordine minimo 20 pz.

COD. 00280

COD. 00290

COD. 00220

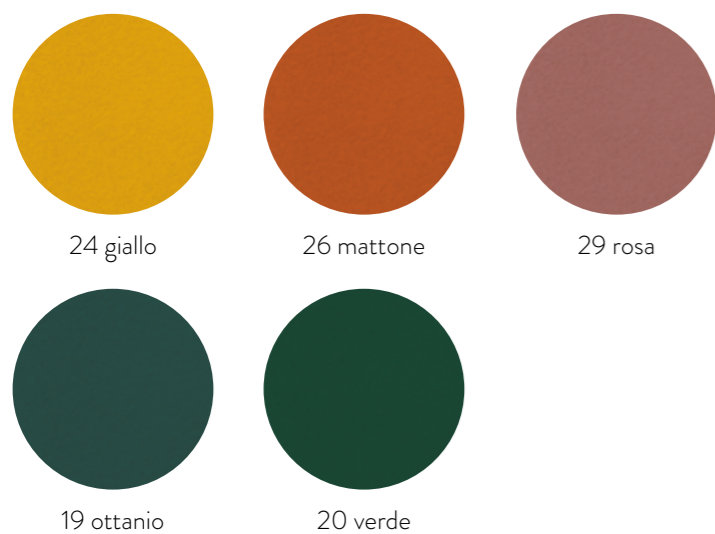
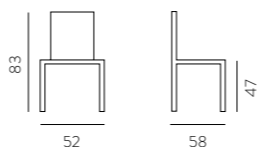

Tessuto bouclé



## poltroncina Art. 381 Pigalle Due

vedi pag. dopo







## Art. 260 Artemisia

- IMBALLO N. 1 pz.
- **NORMALMENTE IN PRONTA CONSEGNA**
- STRUTTURA METALLO VERNICIATA **NERA**
- Velluto a coste antracite COD. 00280

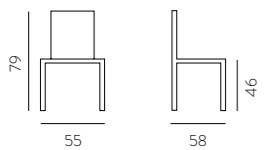

## poltroncina Art. 381 Pigalle Due

- IMBALLO N. 1 pz.
- **TEMPI 30 GG.**
- STRUTTURA METALLO VERNICIATA **NERA** - SUPPLEMENTO BRONZO + € 12,00
- Velluto: **giallo - mattone - rosa - ottanio - verde** COD. 00295
- Tessuto bouclé - ecopelle **VARI COLORI** COD. 00305
- Stoffa cliente (1,5 mt) COD. 00235
- Supplemento gomma ignifuga + € 15,00 / supplemento velluto ignifugo + € 20,00 NB: **ordine minimo 20 pz.**

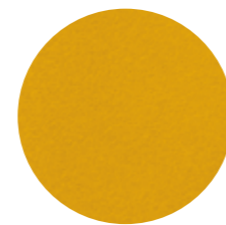
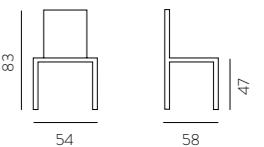

24 giallo

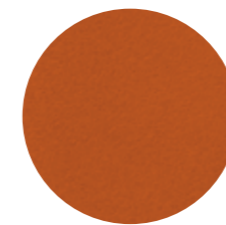

26 mattone

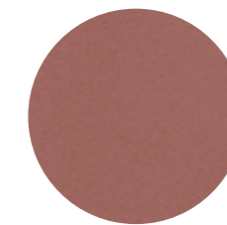

29 rosa

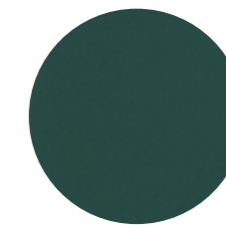

19 ottanio

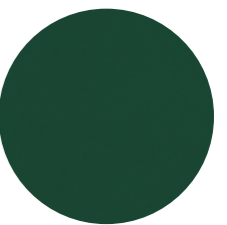

20 verde



## Art. 327 Lynne

■ **STOFFA CUSTOM CAT. B - ORDINE MINIMO 30 PZ. - TEMPI CIRCA 40 GG.**  
**PRODOTTO ARTIGIANALE**

- STRUTTURA VERNICIATA: NERA - BIANCA
- STRUTTURA OTTONE GALVANICO LUCIDO

COD. 00392  
 COD. 00456

L58xP56xH81 - HS46

## Art. 378 Moon

- IMBALLO N. 1 pz.
- GAMBIE: **CROMATE - NERE** ORDINE MINIMO 10 PZ.
- **NORMALMENTE IN PRONTA CONSEGNA**
- ECOPELLE: bianco - nero

COD. 00410

ECOPELLE SPECIAL 30 GG

COD. 00440

STOFFA CLIENTE: 150x140 cm 30 GG

COD. 00380

Ecopelle colori di serie:

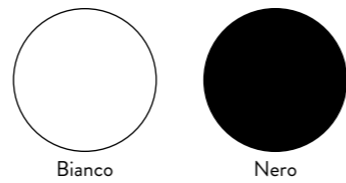

Ecopelle colori speciali:

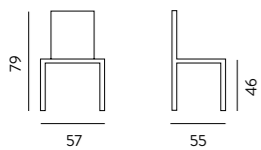
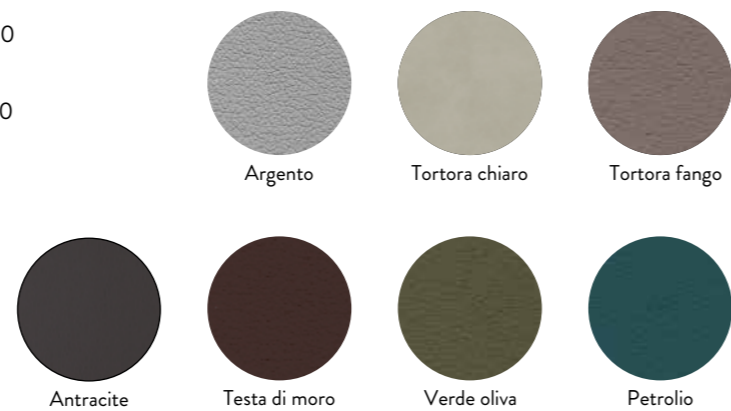



## Art. 211/4G Cabiria 4G

- IMBALLO N. 1 pz. - **SOLO CON TESSUTI DI SERIE**
- **NORMALMENTE IN PRONTA CONSEGNA**
- **BASE 4 GAMBE VERNICIATA NERA**
- **ECOPELLE: tortora fango - titanio** COD. 00338
- **VELLUTO ANTIMACCHIA grigio cenere** COD. 00338

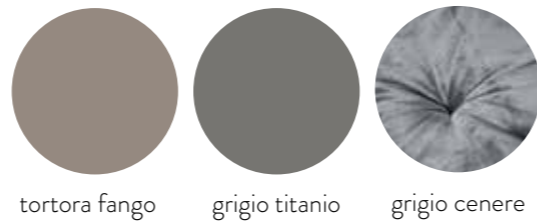

## Art. 211/CS Cabiria custom

- **ORDINE MINIMO 4 PZ.**  
SOTTO 4 PZ. GESTIONE TECNICA € 30,00 netti  
**TEMPI 30 GG**
- **STRUTTURA METALLO VERNICIATA NERA**
- **VELLUTO ANTIMACCHIA**
- **AQUACLEAN**
- **STOFFA CLIENTE (1,5 MT)**

COD. 00430

COD. 00460

COD. 00380

Il velluto potrebbe presentare effetti che non sono da considerare difettosità in quanto caratteristiche della composizione e del tipo di lavorazione: effetto a macchia o marazzatura, effetto chiaro/scuro, effetto impronta

Supplemento velluto ignifugo + € 20,00

NB: ordine minimo 20 pz.

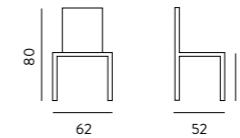



## Art. 253/CS Carnaby custom

- **ORDINE MINIMO 4 PZ.**  
SOTTO 4 PZ. GESTIONE TECNICA € 30,00 netti  
**TEMPI 30 GG**

- STRUTTURA METALLO VERNICIATA **NERA**

- ECOPELLE CAT. B COD. 00320
- VELLUTO ANTIMACCHIA COD. 00320
- STOFFA CLIENTE (1,5 MT) COD. 00280

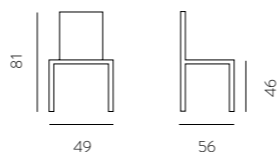

Supplemento velluto ignifugo + € 20,00  
NB: ordine minimo 20 pz.

## Art. 253/4G Carnaby 4G

- **IMBALLO N. 2 pz. - SOLO CON TESSUTI DI SERIE**  
Imballo speciale 1 pz. + 10,00 netto

- **NORMALMENTE IN PRONTA CONSEGNA**

- **BASE 4 GAMBE VERNICIATA NERA**
- ECOPELLE: tortora fango - titanio COD. 00216
- VELLUTO ANTIMACCHIA grigio cenere COD. 00216

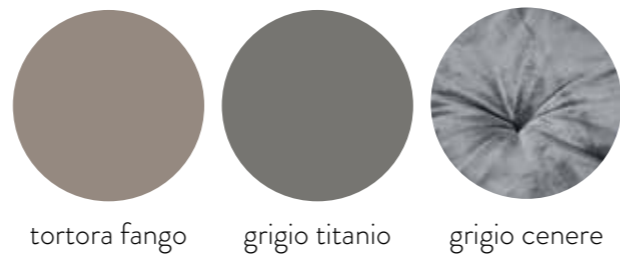

tortora fango

grigio titanio

grigio cenere



Il velluto potrebbe presentare effetti che non sono da considerare difettosità in quanto caratteristiche della composizione e del tipo di lavorazione: effetto a macchia o marazzatura, effetto chiaro/scuro, effetto impronta



VERSIONE UNICOLOR

VERSIONE NABUK

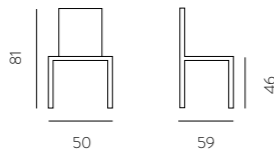

Art. 210 Norway

- IMBALLO N. 2 pz.
- **NORMALMENTE IN PRONTA CONSEGNA**
- STRUTTURA METALLO VERNICIATA IN TINTA
- SEDILI ECOPELLE: ghiaccio - tortora fango - titanio - nero
- STRUTTURA METALLO VERNICIATA NERA
- SEDILI ECO NABUK: beige - grigio

COD. 00228

COD. 00228



**CUSTOM** solo base nera

stoffa cliente COD. 00265  
mt. 1,5 cad.

tessuto cat. B COD. 00297  
ECOPELLE - VELLUTO

Supplemento gomma ignifuga + € 15,00  
Supplemento velluto ignifugo + € 20,00  
NB: ordine minimo 20 pz.





## Art. 240 Sinfonia

- IMBALLO N. 4 pz.  
Imballo speciale 1/3 pz. + 10,00 netto
- **NORMALMENTE IN PRONTA CONSEGNA**
- STRUTTURA METALLO
- GAMBE RIVESTITE ECOPELLE: bianco-sabbia
- GAMBE VERNICIATE IN TINTA ECOPELLE: titanio

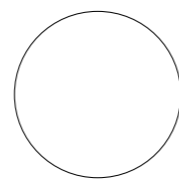

bianco



sabbia

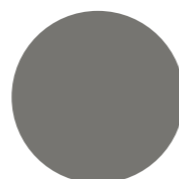

grigio titanio

COD. 00208

COD. 00208

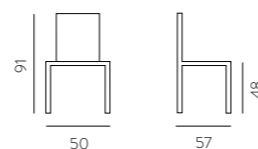

**CUSTOM** gamba verniciata **nera** - TEMPI 40 GG.

tessuto cat. B  
ECOPELLE - VELLUTO

COD. 00301

stoffa cliente  
mt. 1,5 cad.

COD. 00268

Supplemento velluto ignifugo + € 20,00  
NB: ordine minimo 20 pz.





## Sinfonia **Custom**

gamba verniciata NERA - TEMPI 40 GG.

tessuto cat. B  
ECOPELLE - VELLUTO

COD. 00301

stoffa cliente  
mt. 1,5 cad.

COD. 00268

IN BIANCO (già gommate) TAPPEZZERIA CLIENTE COD. 00149

Supplemento velluto ignifugo + € 20,00  
NB: ordine minimo 20 pz.



Supplemento gomma ignifuga + € 15,00  
 Supplemento velluto ignifugo + € 20,00  
 NB: ordine minimo 20 pz.



La tinta delle gambe, essendo materiale naturale, può variare da partita a partita

## Art. 130 Finland

- IMBALLO N. 4 pz.
- **NORMALMENTE IN PRONTA CONSEGNA**
- **GAMBE:**  
MASSELLO TINTO: naturale - noce medio
- **SEDILE:**  
ECOPELLE: bianca - sabbia - titanio

COD. 00206

### CUSTOM

stoffa cliente COD. 00265  
 mt. 1,3 cad.

tessuto cat. B COD. 00297  
 ECOPELLE - VELLUTO

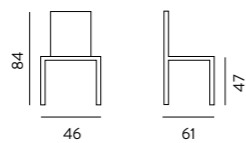





Ecopelle NB: ordine minimo 50 pz.

## Art. 148 **Amanda**

GAMBE **ROVERE MASSELLO** TINTE:  
noce canaletto - rovere - anilina nera

L51-P55-HS48-HT89

VELLUTO DAVIS COD. 00238

grigio 91 - antracite 95

tortora chiaro 16 - brown 26

verde pistacchio 36 - senape 41 - mattone 51

**NORMALMENTE IN PRONTA CONSEGNA**

STOFFA CLIENTE 1,7 MT COD. 00258

ECOPELLE colori vedi sopra COD. 00258

Supplemento gomma ignifuga + € 15,00

Supplemento velluto ignifugo + € 20,00

NB: ordine minimo 50 pz.

**TEMPI 60 GG.**

NB: ORDINE MINIMO 8 PZ. CON ACCONTO - TEMPI 40/50 GG.



Imbottitura rifinita con cordino Piping



oak - rovere chiaro



light walnut - noce chiaro



walnut - noce medio



anilina nera

## Valentina

GAMBE FAGGIO MASSELLO VARIE TINTE

**sedia Art. 140** - L53-P54-HS47-HT80

TESSUTO CAT. B COD. 00428

STOFFA CLIENTE 1,7 MT COD. 00360

**sgabello Art. 141** - L52-P54-HS77-HT106

TESSUTO CAT. B COD. 00552

STOFFA CLIENTE 1,7 MT COD. 00484

gomma ignifuga + € 12,00

Velluto ignifugo + € 26,00 (ordine min. 20 pz.)





**NB: ORDINE MINIMO 8 PZ. CON ACCONTO - TEMPI 40/50 GG.**

## mod. Clelia

STRUTTURA FAGGIO MASSELLO VARIE TINTE  
tinte vedi pag. prima (Valentina)

**sedia Art. 142** - L52-P52-HS47-HT81  
TESSUTO CAT. B COD. 00387  
STOFFA CLIENTE 1,6 MT COD. 00320

**sgabello Art. 143** - L52-P54-HS77-HT106  
TESSUTO CAT. B COD. 00498  
STOFFA CLIENTE 1,4 MT COD. 00444

gomma ignifuga + € 12,00  
Velluto ignifugo + € 26,00 (ordine min. 20 pz.)



## Art. 324 Pickford

L52-P55-HS47-HB65-HT80

■ **ORDINE MINIMO 10 PZ. con acconto - TEMPI 40/50 GG**  
sotto 10 pz. costo gestione € 120,00

■ **STOFFE CATEGORIA B**  
(ecopelle - velluto non ignifugo) pag. 252 - VOL 1  
sedile cinghiato, rifinito con cordino piping

GAMBE FAGGIO QUADRE O TONDE  
tinte vedi pag. prima (Valentina)

TESSUTO CAT. B COD. 00496  
STOFFA CLIENTE 1,5 MT COD. 00446



accessorio PUNTALE OTTONE + € 79,00





SEDILE a SAPONETTA



SEDILE a COSTINA

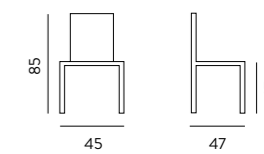

## Art. 329 Brighton

■ IMBALLO N. 2 pz.

■ ORDINE MINIMO 30 PZ - TEMPI 40/50 GG

TESSUTO CAT. B COD. 00296  
 STOFFA CLIENTE 0,6 MT COD. 00278

Scegliere tipo di Canna (schienale) e tipo di sedile (saponetta o costina)



naturale



rovere chiaro

STRUTTURA  
 FAGGIO VARIE TINTE  
 O AL CAMPIONE



noce chiaro



noce medio



anilina nera

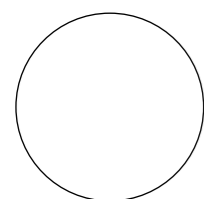

bianco



sabbia

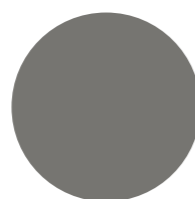

titanio



## Art. 095 New Age

■ IMBALLO N. 2 pz.  
 Imballo speciale 1 pz. + 10,00 netto

■ NORMALMENTE IN PRONTA CONSEGNA

■ STRUTTURA LACCATO:

BIANCO

SABBIA

TITANIO

■ SEDILI

ECOPELLE IN TINTA

COD. 00138

COD. 00138

COD. 00138

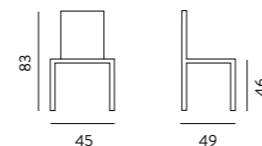

CANNA MIDOLLINO



CANNA CLASSICA



## TINTE & STOFFE A CAMPIONARIO

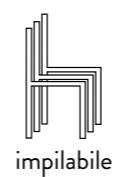

impilabile

### mod. Almond

STRUTTURA FAGGIO MASSELLO VARIE TINTE

**SEDIA Art. 144** - L53-P55-HS47-HT82

SCHIENALE LEGNO  
SCHIENALE IMBOTTITO  
SCHIENALE CANNA

**SGABELLO Art. 145** - L55-P60-HS75-HT109

SCHIENALE LEGNO  
SCHIENALE IMBOTTITO  
SCHIENALE CANNA

TESSUTO CLIENTE:  
solo sedile 0,5 mt meno € 20,00 - sedile e schienale 0,9 mt meno € 36,00

Sedile imbottito  
CAT. B

COD. 00232  
COD. 00340  
COD. 00332

COD. 00436  
COD. 00512  
COD. 00536



Sedile legno

COD. 00232  
-  
COD. 00332

COD. 00436  
-  
COD. 00536





Piano Art. 1050/29 Vitrum



### Art. 321 Breakfast

L43-P48-HS49-HT85

TESSUTO CAT. B COD. 00227

STOFFA CLIENTE 0,80 MT COD. 00208

RIFINITURA IMBOTTITURA SCHIENALE CON PIPING

TEMPI CA 40 GG.  
NB: ordine min 20 pz. con acconto

Imbottitura rifinita con cordino Piping

### Art. 325 Breakfast Stool

TESSUTO CAT. B  
COD. 00326



### Art. 322 Breakfast XL

TESSUTO CAT. B COD. 00284  
STOFFA CLIENTE 1MT COD. 00248

TEMPI CA 40 GG.  
NB: ordine min 20 pz. con acconto



TINTE & STOFFE  
A CAMPIONARIO



# TESSUTI A MAGAZZINO PER MODELLI CUSTOM

## VELLUTO ANTIMACCHIA non ignifugo CAT B

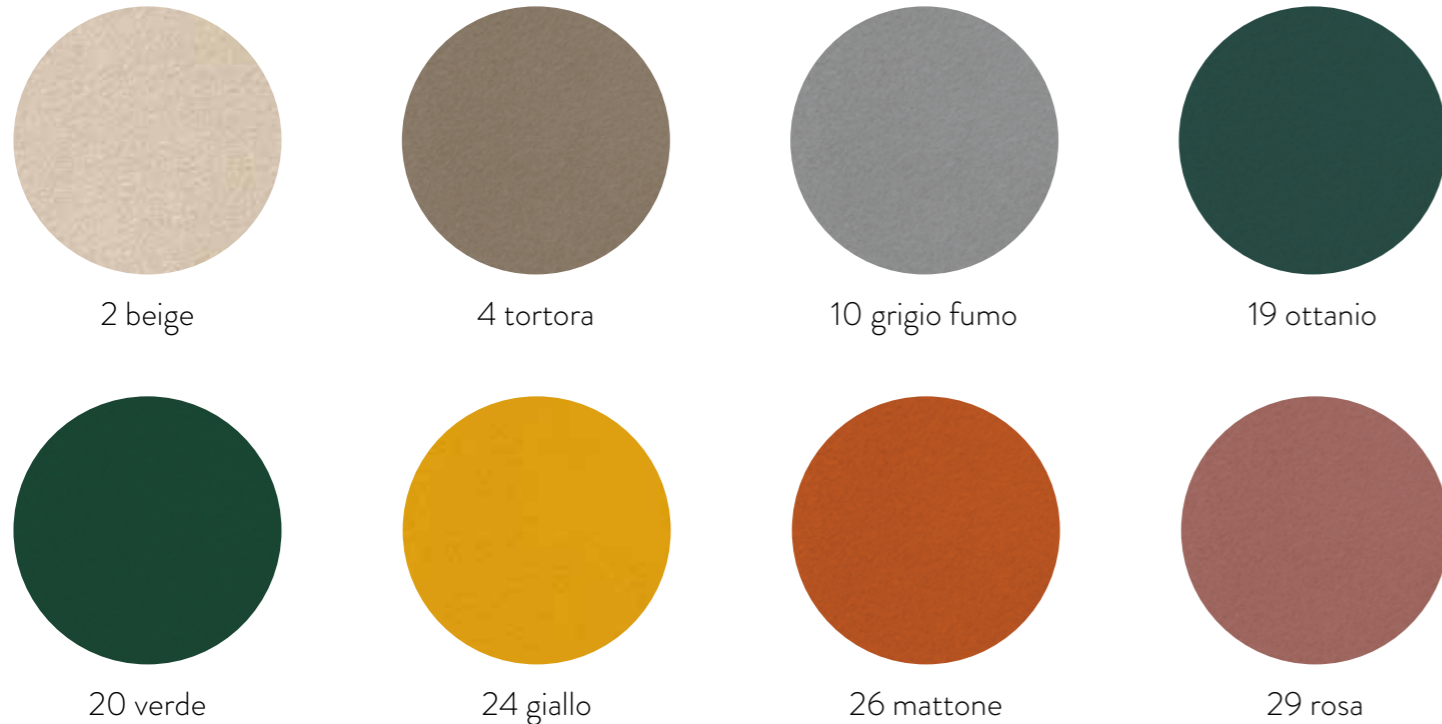

IL VELLUTO POTREBBE PRESENTARE EFFETTI CHE NON SONO DA CONSIDERARE DIFETTOSITÀ IN QUANTO CARATTERISTICHE DELLA COMPOSIZIONE E DEL TIPO DI LAVORAZIONE: EFFETTO A MACCHIA O MARAZZATURA, EFFETTO CHIARO/SCURO, EFFETTO IMPRONTA

## ECOPELLE ignifuga CAT B



L'ECOPELLE NEI COLORI CHIARI POTREBBE MACCHIARSI A CONTATTO CON INDUMENTI NON TRATTATI (ES. JEANS). PER LA PULIZIA DEI PRODOTTI UTILIZZARE SOLO ACQUA TIEPIDA E UN PANNINO MORBIDO IN MICROFIBRA. NON USARE SOLVENTI O PRODOTTI AGGRESSIVI.

# VELLUTO COLORI SU ORDINAZIONE PER MODELLI CUSTOM

## VELLUTO ANTIMACCHIA non ignifugo CAT B ( ignifugo CAT C)



## ECONABUK FAST CLEAN idrorepellente CAT B



SCARICA QR  
PER LE INCREDIBILI PERFORMANCE



colori a magazzino, vedi pag. 98/99 (Cloe Plus)



**CUSTOM** min 80 pz.

Supplemento gomma ignifuga + € 15,00  
 Supplemento velluto ignifugo + € 20,00  
 NB: ordine minimo 20 pz.



Art. 215 **Hellen Plus**

- **IMBALLO** N. 4 pz.  
Imballo speciale 1/3 pz. + 10,00 netto
- **NORMALMENTE IN PRONTA CONSEGNA**
- **STRUTTURA VERNICIATA NERA**

- **SEDILI**  
ECOPELLE titanio
- **VELLUTO ANTIMACCHIA:**  
grigio fumo - tortora - verde - ottanio - blu

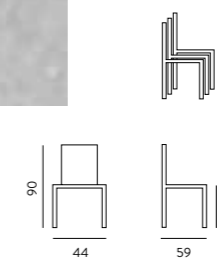

COD. 00187

COD. 00187



Il velluto potrebbe presentare effetti che non sono da considerare difettosità in quanto caratteristiche della composizione e del tipo di lavorazione: effetto a macchia o marazzatura, effetto chiaro/scuro, effetto impronta



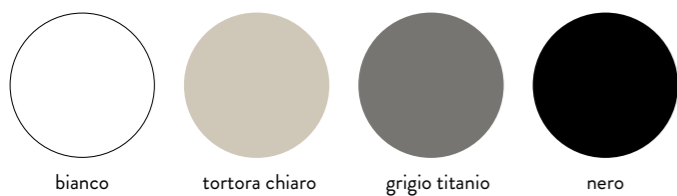

L'ecopelle nei colori chiari potrebbe macchiarsi a contatto con indumenti non trattati (es. jeans). Per la pulizia dei prodotti utilizzare solo acqua tiepida e un panno morbido in microfibra. Non usare solventi o prodotti aggressivi.

## Art. 213 Hellen Classic

■ **IMBALLO N. 4 pz.**  
Imballo speciale 1/3 pz. + 10,00 netto

■ **NORMALMENTE IN PRONTA CONSEGNA**

■ <b>STRUTTURA:</b>	ECOPELLE IN TINTA	VERNICIATA IN TINTA
■ <b>SEDILI</b>	-	COD. 00167
ECOPELLE: bianco - nero	-	COD. 00167
ECOPELLE: tortora chiaro - grigio titanio	COD. 00167	-

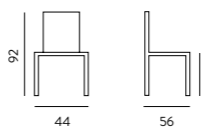



ECONABUK  
FAST CLEAN IDROREPELENTE



SCARICA QR  
PER LE INCREDIBILI PERFORMANCE

ECONABUK  
FAST CLEAN IDROREPELENTE



## Art. 219 Cloe Plus

- IMBALLO N. 4 pz.
- **NORMALMENTE IN PRONTA CONSEGNA**
- STRUTTURA METALLO RICOPERTA
- SEDILI

ECONABUK **FAST CLEAN**: antracite - ghiaccio - tortora - kiwi - mattone - senape - celeste COD.00178

## CUSTOM

CON UN MINIMO D'ORDINE 50 PZ.

A RICHIESTA CON GAMBE VERNICIATE  
VARI COLORI (NON RICOPERTE)

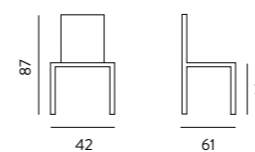



GAMBE METALLO  
IN TINTA

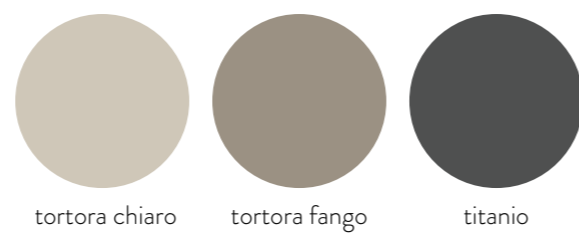

tortora chiaro

tortora fango

titanio

## Art. 220 Naked

■ **IMBALLO N. 4 pz.**

Imballo speciale 1/3 pz. + 10,00 netto

■ **NORMALMENTE IN PRONTA CONSEGNA**

■ **STRUTTURA METALLO VERNICIATA IN TINTA**

■ **SEDILI**

ECOPELLE:

tortora chiaro - tortora fango - titanio

COD. 00163

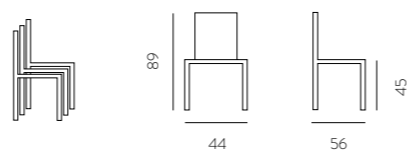

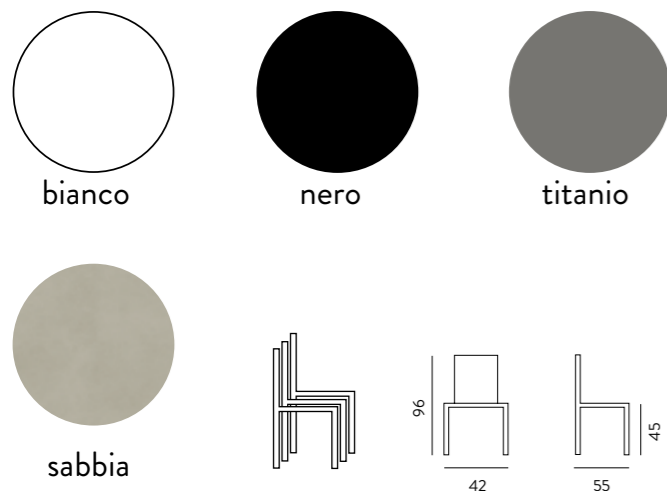

### Art. 232 **Vanity**

- IMBALLO N. 4 pz.
- **NORMALMENTE IN PRONTA CONSEGNA**
- STRUTTURA METALLO RIVESTITO SIMILCUOIO PVC:

**bianco - nero - titanio - sabbia** COD. 00158

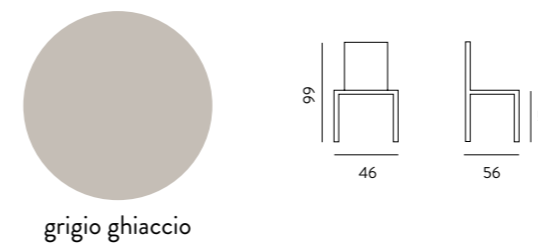

corredate di vitone tirafondi per ulteriore robustezza

### Art. 116 **Class**

- IMBALLO N. 2 pz.
- **NORMALMENTE IN PRONTA CONSEGNA**
- STRUTTURA: LACCATO IN TINTA
- SEDILI  
ECOPELLE grigio ghiaccio COD. 00128



L'ecopelle nei colori chiari potrebbe macchiarsi a contatto con indumenti non trattati (es. jeans). Per la pulizia dei prodotti utilizzare solo acqua tiepida e un panno morbido in microfibra. Non usare solventi o prodotti aggressivi.

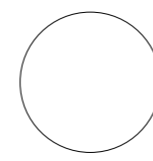

bianco



sabbia

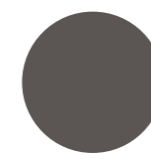

titanio

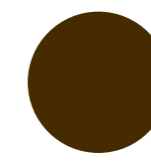

testa di moro



grigio ghiaccio

L'ecopelle nei colori chiari potrebbe macchiarsi a contatto con indumenti non trattati (es. jeans).  
Per la pulizia dei prodotti utilizzare solo acqua tiepida e un panno morbido in microfibra.  
Non usare solventi o prodotti aggressivi.

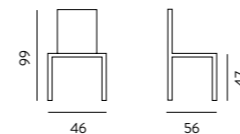

corredate di  
vitone tirafondi per  
ulteriore robustezza  
USO CONTRACT

## Art. 122 Vertigo Slim

- IMBALLO N. 2 pz.
- **NORMALMENTE IN PRONTA CONSEGNA**
- STRUTTURA LACCATO IN TINTA
- SEDILI  
ECOPELLE: bianco - sabbia - titanio - grigio ghiaccio  
STRUTTURA laccata in tinta
- ECOPELLE: testa di moro/STRUTTURA wengè

COD. 00117 (con cover COD. 00215)

COD. 00117 (con cover COD. 00215)



## Art. 126 Cover

solo per Art. 122/116  
COTONE QUALITY

COD. 0098 solo cover

sabbia

bianco lino



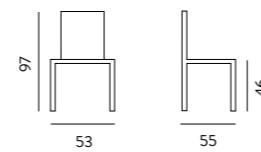

## Art. 028 Regina

- **IMBALLO N. 2 pz.**  
Imballo speciale 1 pz. + 10,00 netto

- **NORMALMENTE IN PRONTA CONSEGNA**

- **STRUTTURA:** POLICARBONATO

trasparente COD. 00196

fumè COD. 00207

### PRODOTTI IN POLICARBONATO

Data la particolare tecnologia di questo articolo il prodotto potrebbe presentare dei segni superficiali, queste particolarità non riducono le caratteristiche di estetica e resistenza del prodotto.

### Avvertenze e manutenzione:

pulire con panno morbido, non abrasivo, imbevuto di sola acqua

### Non usare:

solventi, sgrassanti, alcool etilico e detersivi (perchè tendono a cristallizzare, facendo perdere le capacità di flessibilità e alta resistenza al prodotto)





### Art. 033/6 Rainbow

- IMBALLO N. 4 pz.  
Imballo speciale 1/3 pz. + 10,00 netto
  - **NORMALMENTE IN PRONTA CONSEGNA**
  - STRUTTURA:  
POLICARBONATO
- trasparente COD. 00134

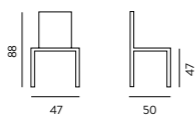

### Poltroncina Art. 033/2 Ink-B

- IMBALLO N. 4 pz.  
Imballo speciale 1/3 pz. + 10,00 netto
- **NORMALMENTE IN PRONTA CONSEGNA**

■ STRUTTURA:  
POLICARBONATO

trasparente - fumè

COD. 00196

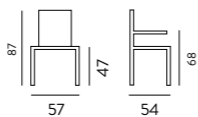

### Sedia Art. 033/1 Ink versione fumè

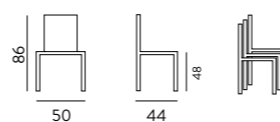

### Art. 033/1 Ink

- IMBALLO N. 4 pz.  
Imballo speciale 1/3 pz. + 10,00 netto
- **NORMALMENTE IN PRONTA CONSEGNA**
- STRUTTURA POLICARBONATO

trasparente COD. 00149  
trasparente fumè COD. 00158

**VERSIONE IGNIFUGA**  
ordine min. 20 pz. anche misti  
Imballo 4 pz. - TEMPI 20/30 GG.

sedia Art. 033/1 IG COD. 00178  
colori: trasparente - bianco lucido

poltroncina Art. 033/2 IG COD. 00209  
colori: trasparente



Sgabello 544 Ink Stool - H 65 / 74

PRODOTTI IN POLICARBONATO  
Data la particolare tecnologia di questo articolo il prodotto potrebbe presentare dei segni superficiali, queste particolarità non riducono le caratteristiche di estetica e resistenza del prodotto.

Avvertenze e manutenzione:  
pulire con panno morbido, non abrasivo, imbevuto di sola acqua  
**Non usare:**  
solventi, sgrassanti, alcool etilico e detersivi (perchè tendono a cristallizzare, facendo perdere le capacità di flessibilità e alta resistenza al prodotto)

carrello  
Art. 1400.2943  
Imballo 2 pz.  
COD. 00215

maniglione  
Art. 1400.2947  
COD. 0060

Porta 12 sedie



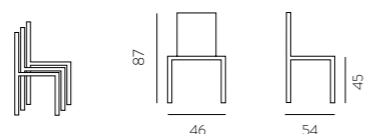

### Art. 029 Voilà

- **IMBALLO N. 4 pz.**  
Imballo speciale 1/3 pz. + 10,00 netto
- **NORMALMENTE IN PRONTA CONSEGNA**
- **STRUTTURA:** POLICARBONATO
- **SEDILI**  
trasparente COD. 00176

**PRODOTTI IN POLICARBONATO**  
Data la particolare tecnologia di questo articolo il prodotto potrebbe presentare dei segni superficiali, queste particolarità non riducono le caratteristiche di estetica e resistenza del prodotto.

Avvertenze e manutenzione:  
pulire con panno morbido, non abrasivo, imbevuto di sola acqua  
**Non usare:**  
solventi, sgrassanti, alcool etilico e detersivi (perchè tendono a cristallizzare, facendo perdere la capacità di flessibilità e alta resistenza al prodotto)



### Art. 037/1 Valery-S

- **IMBALLO N. 4 pz.**  
Imballo speciale 1/3 pz. + 10,00 netto
- **NORMALMENTE IN PRONTA CONSEGNA**
- **STRUTTURA:** POLICARBONATO
- trasparente COD. 00149
- trasparente fumè COD. 00149
- trasparente **ignifugo\*** COD. 00178

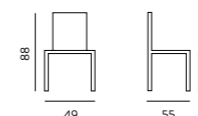

**\* VERSIONE IGNIFUGA**  
ordine min. 20 pz. anche misti  
TEMPI 20/30 GG. (no apertura imballo)



### Art. 037/2 Valery-P

- **IMBALLO N. 2 pz.**  
Imballo speciale 1 pz. + 10,00 netto
- **NORMALMENTE IN PRONTA CONSEGNA**
- **STRUTTURA:** POLICARBONATO
- trasparente COD. 00167
- trasparente fumè COD. 00167
- trasparente **ignifugo\*** COD. 00209

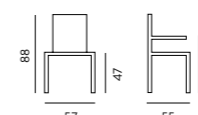





## Art. 022 Shell Wood

- **IMBALLO N. 2 pz.**  
Imballo speciale 1 pz. + 10,00 netto
- **NORMALMENTE IN PRONTA CONSEGNA**
- **GAMBE:**  
MASSELLO DI FAGGIO: tinto naturale
- **SEDILE:**  
POLIPROPILENE: bianco - grigio quarzo - nero

COD. 00129

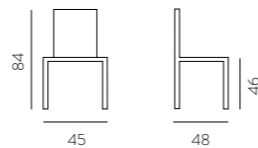

## Art. 522 Shell Stool

**NB: H SEDILE 65 CM**

- **IMBALLO N. 4 pz.**  
Imballo speciale 1/3 pz. + 10,00 netto
  - **NORMALMENTE IN PRONTA CONSEGNA**
  - **GAMBE:** MASSELLO DI FAGGIO: tinto naturale
  - **SEDILE:**  
POLIPROPILENE: bianco - grigio quarzo - nero
- COD. 00166

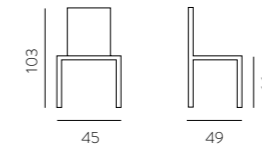



## Art. 03 Idol

- **IMBALLO N. 4 pz.**

Imballo speciale 1/3 pz. + 10,00 netto

- **NORMALMENTE IN PRONTA CONSEGNA**

- **STRUTTURA NERA**

- **SEDILI POLIPROPILENE:**

grigio - nero - senape - ottanio

COD. 00119

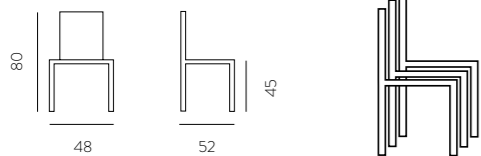



## Art. 019 Shell Metal

■ **IMBALLO N. 4 pz.**  
Imballo speciale 1/3 pz. + 10,00 netto

■ **NORMALMENTE IN PRONTA CONSEGNA**

■ **STRUTTURA:** CROMATO

■ **SEDILI**  
POLIPROPILENE:  
bianco - grigio quarzo COD. 00119

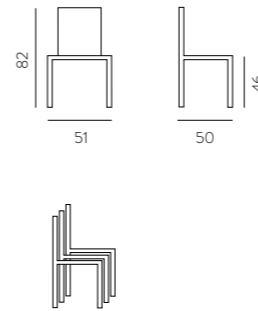

## Art. 027 Alina

■ **IMBALLO N. 4 pz.**  
Imballo speciale 1/3 pz. + 10,00 netto

■ **NORMALMENTE IN PRONTA CONSEGNA**

- POLIPROPILENE **BIANCO PANNA**/METALLO BIANCO PANNA
- POLIPROPILENE **TORTORA**/METALLO BIANCO PANNA
- POLIPROPILENE **ANTRACITE**/METALLO ANTRACITE

COD. 00129  
COD. 00129  
COD. 00129

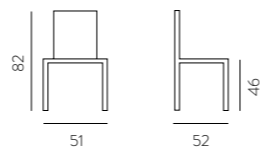
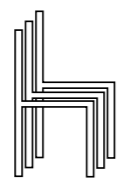



INDOOR / OUTDOOR

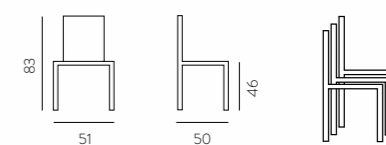

## Art. 014 Vela

- **IMBALLO N. 4 pz.**  
Imballo speciale 1/3 pz. + 10,00 netto
- **NORMALMENTE IN PRONTA CONSEGNA**
- **POLIPROPILENE:** COD. 0087  
grigia - tortora - nero - bianco  
mattone - senape - verde bosco - avio

### ORDINI A STOCK

- **IMBALLO A PILE N. 25 pz. monocolore**
- ordini 2/3 pile COD. 0082
- ordini 4 pile in su COD. 0078





## Art. 048 Neos

INDOOR / OUTDOOR



- **IMBALLO N. 4 pz.**  
Imballo speciale 1/3 pz. + 10,00 netto
  - **NORMALMENTE IN PRONTA CONSEGNA**
  - **POLIPROPILENE:**  
bianco - grigio avio - nero - tortora
- COD. 0096

### ORDINI A STOCK

- **IMBALLO A PILE N. 22 pz. monocolore**
- ordini 2/3 pile            COD. 0092
- ordini 4 pile in su        COD. 0089

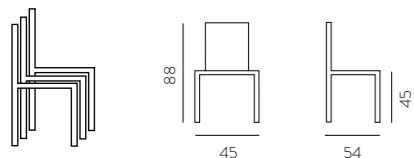



Art. 09 Fly

INDOOR / OUTDOOR

■ IMBALLO N. 4 pz.



- POLIPROPILENE:
- TUTTA: BIANCA - ANTRACITE
- BICOLORE SABBIA / BIANCA
- **NORMALMENTE IN PRONTA CONSEGNA**

COD. 00126

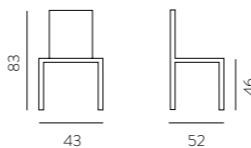

COD. 0096

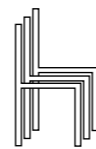

Impilabile 2 pz.

**FLY COLOR**  
 STRUTTURA NERA / sedile e schienale:  
 OTTANIO - VERDE - MATTONE - GIALLO  
**DISPONIBILI DA NOVEMBRE 2023**





INDOOR / OUTDOOR



## Art. 040 Citylife

■ **IMBALLO N. 4 pz.**

Imballo speciale 1/3 pz. + 10,00 netto

■ **NORMALMENTE IN PRONTA CONSEGNA**

■ **POLIPROPILENE:**

COD. 00118

**bianco - grigio - nero - tortora  
ottanio - senape - verde**

NB: Gli eventuali segni di stampaggio sono fisiologici, dovuti all'utilizzo del Fiberglass per dare struttura e solidità al prodotto

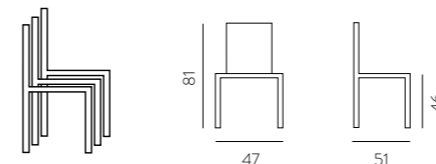



INDOOR / OUTDOOR



Sedia Art. 051 Zerocinquantuno

■ IMBALLO N. 4 pz.  
Imballo speciale 1/3 pz. + 10,00 netto

■ **NORMALMENTE IN PRONTA CONSEGNA**

■ POLIPROPILENE:  
antracite - tortora - grigio chiaro - bianco - senape - verde oliva - ottanio - cipria

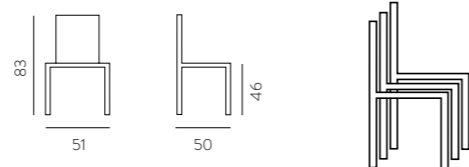

COD. 00119





## Sedia Art. 050 River

■ PILE N. 24 pz.  
apertura pila +10,00 netto

■ **NORMALMENTE IN PRONTA CONSEGNA**

■ **STRUTTURA:**  
RESINA RINFORZATA CON FIBERGLASS  
COLORI:  
sabbia - bianco - tortora - antracite - rosso - celeste - verde oliva

COD. 00109

River Stool

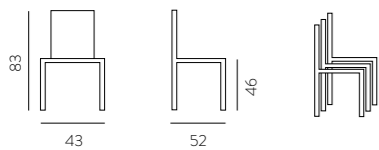

bianco  
sabbia  
tortora  
antracite

INDOOR / OUTDOOR





## Art. 013 Vivian

- **IMBALLO N. 4 pz.**  
Imballo speciale 1/3 pz. + 10,00 netto
- **NORMALMENTE IN PRONTA CONSEGNA**
- **STRUTTURA POLIPROPILENE:**  
bianco - tortora - nero      COD. 0096

### ORDINI A STOCK

- **IMBALLO A PILE N. 23 pz. monocolore**  
ordini 2/3 pile      COD. 0089  
ordini 4 pile in su      COD. 0082

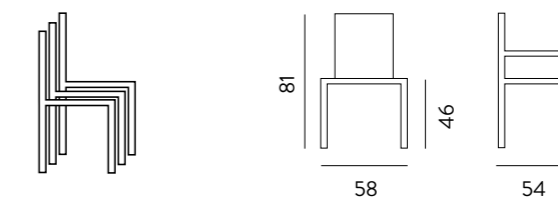

INDOOR / OUTDOOR



INDOOR / OUTDOOR

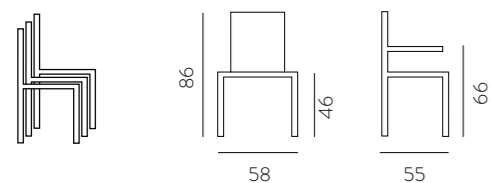

## Art. 055 River-B

- **PILE N. 24 pz.**  
apertura pila + 10,00 netto
- **NORMALMENTE IN PRONTA CONSEGNA**
- **RESINA RINFORZATA CON FIBERGLASS:**  
bianco - celeste - tortora - antracite      COD. 00118



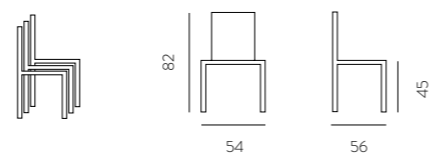

## Art. 08 Pilar

- **IMBALLO N. 4 pz.**  
Imballo speciale 1/3 pz. + 10,00 netto
- **NORMALMENTE IN PRONTA CONSEGNA**

- **POLIPROPILENE: bianco - sabbia - antracite** COD. 00126  
NB: nel colore antracite sono presenti i leggeri segni dello stampaggio

INDOOR / OUTDOOR





sedia appendibile,  
pratica e comoda per le pulizie

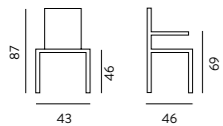

## Art. 056 Brera

■ IMBALLO N. 4 pz.  
Imballo speciale 1/3 pz. + 10,00 netto

■ **NORMALMENTE IN PRONTA CONSEGNA**

■ STRUTTURA POLIPROPILENE:

bianco - tortora - nero - senape - verde - ottanio

COD. 00138

INDOOR / OUTDOOR



NB: sui colori scuri sono presenti i segni dello stampaggio  
il colore nero per uso outdoor va tenuto in zone ombreggiate



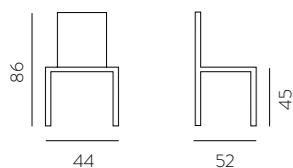

Art. 528 **Stool**  
NB: SOLO H65 COD. 00138

fino a 10 pz.

## Art. 057 **Vienna 2.0**

- PILE N. 14 pz.  
apertura pila + 10,00 netto
- **NORMALMENTE IN PRONTA CONSEGNA**
- **POLIPROPILENE: bianco - sabbia - antracite**

COD. 0098



INDOOR / OUTDOOR



INDOOR / OUTDOOR



## Art. 078 **Borgo Antico**

- **IMBALLO PILE N. 14 pz. monocolore**  
apertura imballo + 10,00 netto
- **NORMALMENTE IN PRONTA CONSEGNA**
- **RESINA RINFORZATA CON FIBERGLASS:**  
**bianco - sabbia** COD. 0099

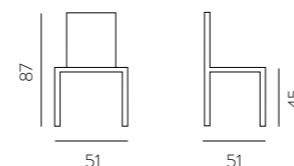



## Art. 077 Corsocomo

- IMBALLO N. 4 pz.  
Imballo speciale 1/3 pz. + 10,00 netto
- **NORMALMENTE IN PRONTA CONSEGNA**
- STRUTTURA POLIPROPILENE  
bianco - sabbia - tortora - nera

COD. 00118



..... bianco      ..... tortora      ..... sabbia

INDOOR / OUTDOOR



## Art. 045 Falena Velvet

- PILE N. 22 pz.  
apertura pila + 10,00 netto
- **NORMALMENTE IN PRONTA CONSEGNA**
- POLIPROPILENE OPACO: bianco - tortora chiaro

COD. 00118

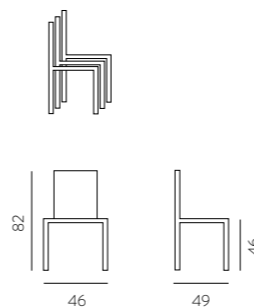



Base non disponibile vedi Art. 1779 Croce



## INDOOR / OUTDOOR



### Art. 042 Cab

■ **IMBALLO N. 4 pz.**  
Imballo speciale 1/3 pz. + 10,00 netto

■ **NORMALMENTE IN PRONTA CONSEGNA**

■ **POLIPROPILENE:**  
**bianco - grigio - nero - ottanio**      COD. 00118

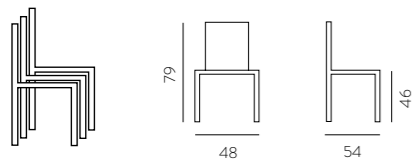

## VERSIONE 100% RECYCLED certificata

### Art. 042/G Cab Green

■ **POLIPROPILENE RICICLATO**  
COLORI: light blu - antracite - grigio

COD. 00127



- **NB: ORDINE MINIMO 20 PZ.** (ANCHE COLORI ASSORTITI)
- **IMBALLO N. 4 pz. MONOCOLORE TAX**
- **TEMPI 20/30 GG**

NB: il polipropilene riciclato potrebbe avere delle leggere alonature dovute alla natura stessa del materiale





## Art. 043 Aurea

L57-P55-HS48-HT77

struttura polipropilene **nero**  
 scocca polipropilene vari colori  
 accessorio cuscinetto velluto o ecopelle

COD. 00136

COD. 0048

**ORDINE MIN. 20 PZ.**

■ **IMBALLO N. 4 pz. monocolore**  
**TEMPI 20/30 GG.**

  
**SNOWBALL**  
**EM**

  
**BLACK**  
**NR**

  
**POWDER**  
**ST**

  
**SWAMP**  
**SC**

  
**MOSS**  
**SD**

  
**CREAM**  
**E7**





## SEDIA CERTIFICATA x COMUNITÀ TECNOPOLIMERO IGNIFUGO CLASSE 1

Art. 1400/1 **Saras**

■ POLIPROPILENE IGNIFUGO

COLORI: bianco panna - giallo - arancio - rosso - grigio chiaro

COD. 00129



bianco panna    giallo    arancio    rosso    grigio chiaro



- NB: ORDINE MINIMO 24 PZ. (ANCHE COLORI ASSORTITI)
- IMBALLO N. 6 pz. MONOCOLORE TAX
- TEMPI 20/30 GG

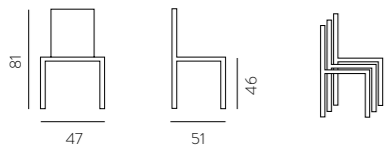

Porta 16 sedie

carrello  
Art. 1400.2943  
Imballo 2 pz.  
COD. 00215

maniglione  
Art. 1400.2947  
COD. 0060

## INDUSTRIAL



NEWS NERO OPACO

Sedia Art. 069 **Route 66**

■ IMBALLO N. 4 pz. COD. 00108

Imballo speciale 1/3 pz. + 10,00 netto

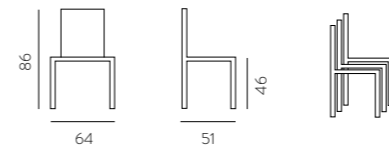

NON ADATTA PER USO OUTDOOR

Route 66 Stool

■ IMBALLO N. 4 pz.

Imballo speciale 1/3 pz. + 10,00 netto

- Art. 590/6 H65 COD. 00108
- Art. 590/7 H74 COD. 00108





Sgabello 590

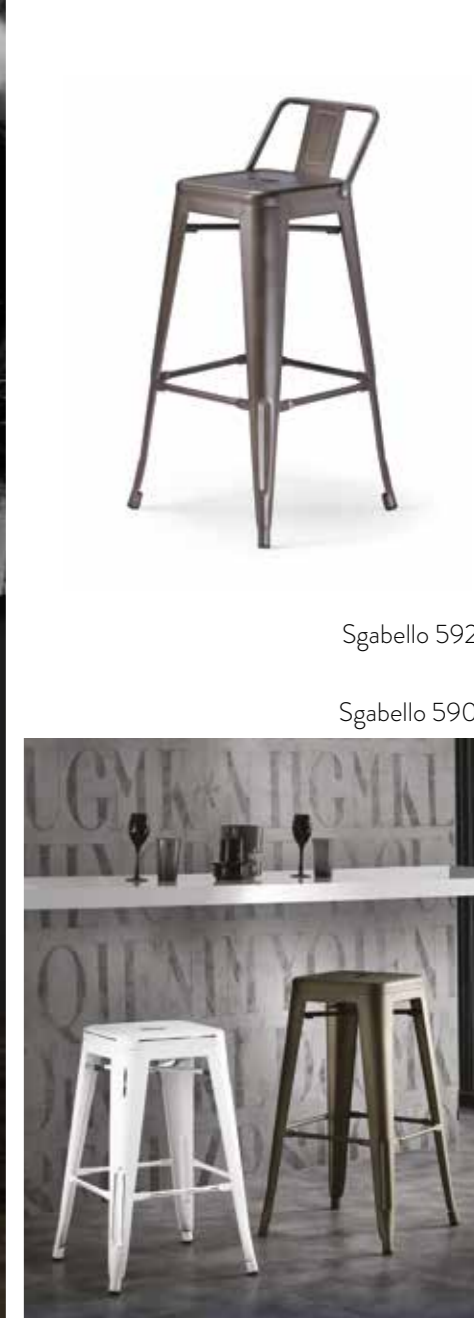

Sgabello 592

Sgabello 590

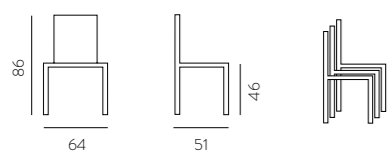

## Art. 069 Route 66

- **IMBALLO N. 4 pz.**  
Imballo speciale 1/3 pz. + 10,00 netto
- **NORMALMENTE IN PRONTA CONSEGNA**
- **STRUTTURA METALLO:** COD. 00136
- **NATURALE PROTETTO DA VERNICE TRASPARENTE**
- **COUNTRY CHIC (BIANCO ANTICATO)**
- **BRUNITO**

NON ADATTA PER USO OUTDOOR





## Art. 214 Dublin

- **IMBALLO N. 2 pz.**  
Imballo speciale 1 pz. + 10,00 netto
  - **NORMALMENTE IN PRONTA CONSEGNA**
  - **GAMBE**  
METALLO VERNICIATO nero
  - **SEDILE ECOPELLE**  
cuoio vissuto cognac
- COD. 00218

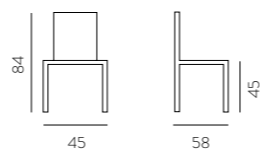

Sgabello pag. 175

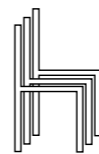
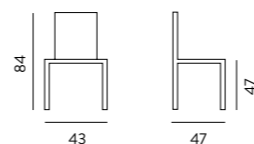

Art. 563  
Italian Graffiti Stool  
NB: H65 COD. 00178

## Art. 063 Italian Graffiti

- **IMBALLO N. 5 pz.**  
Imballo speciale 1/4 pz. + 10,00 netto
  - **NORMALMENTE IN PRONTA CONSEGNA**
  - **STRUTTURA METALLO VERNICIATO nero (TUBO Ø 25 MM)**  
- LAMINATO NERO PLACCATO SU MULTISTRATI
- COD. 0098





verniciato: NERO o FERRO NATURALE  
ecopelle VINTAGE cuciture a coste

TUBO Ø 25  
PRODOTTO CEE - CUSTOMIZZABILE

Art. 066 Irish Chair

L43-P47-HS47-HT84 COD. 00198

Art. 566 Irish Stool

L43-P53-HS82-HT117 COD. 00276

**ORDINE MINIMO 40 PZ - TEMPI 40/50 GG.**

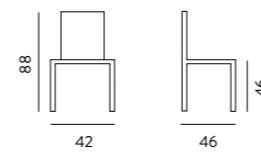

Art. 058 Nature

- IMBALLO N. 2 pz.
- **NORMALMENTE IN PRONTA CONSEGNA**
- STRUTTURA  
FAGGIO/SEDILE PAGLIA DI RISO  
FAGGIO TINTO ANILINA:  
perla-arancio-verde-acquamarina

COD. 0086





## Art. 133 Paesana

■ **IMBALLO N. 2 pz.**  
Imballo speciale 1 pz. + 10,00 netto

■ **NORMALMENTE IN PRONTA CONSEGNA**

■ **SEDILI:**

■ **STRUTTURA**

NOCE CHIARO-NOCE SCURO  
LACCATO BIANCO ANTICATO  
GREZZO



**PAGLIA DI RISO**

COD. 0076  
eliminato  
COD. 0069

**MASSELLO**

COD. 0088  
COD. 00119  
COD. 0076

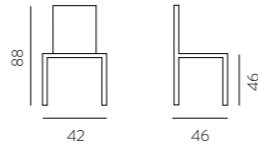

**raso**

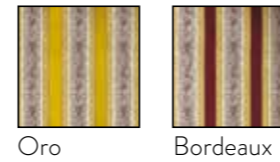

**velluto**

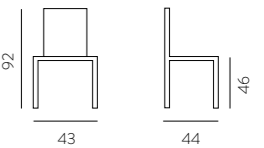
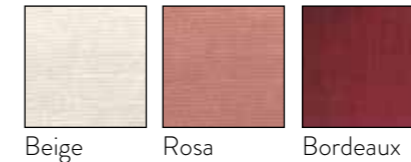

## Art. 583/7 Paesana sgab. H72

■ **IMBALLO N. 2 pz.**  
■ **NORMALMENTE IN PRONTA CONSEGNA**  
NOCE SCURO/PAGLIA DI RISO COD. 00154  
NOCE SCURO/MASSELLO COD. 00164



## tavolo Art. 1010 Classic

■ **ORDINE MINIMO 20 PZ. - TEMPI 20/30 GG.**

struttura massello tinta noce  
piano nobilitato 20 mm (indicato per uso tovaglia)  
- 80x80 COD. 00196  
- Prolunga nobilitato 80x80 COD. 00108  
- Prolunga nobilitato 120x80 COD. 00108

Tavolo tradizionale predisposto di fori per prolunga  
A richiesta con un minimo di quantità,  
anche altre misure e varie tinte



Art. 1010/P - Prolunga per tavoli completa di ferri

## Art. 153 Vecchio Veneto

■ **IMBALLO N. 2 pz.**  
Imballo speciale 1 pz. + 10,00 netto

■ **NORMALMENTE IN PRONTA CONSEGNA**

■ **SEDILI:**

VERA PAGLIA

MASSELLO

VELLUTO - GOBELIN

RASO

■ **STRUTTURA:**  
NOCE SCURO

COD. 00104

COD. 00118

COD. 00128

COD. 00138

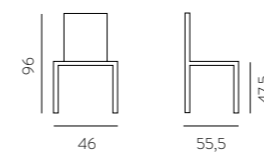

## Art. 149 Castellana

■ **IMBALLO N. 2 pz.**  
Imballo speciale 1 pz. + 10,00 netto  
■ **NORMALMENTE IN PRONTA CONSEGNA**

■ **STRUTTURA:**

NOCE SCURO

■ **SEDILI MASSELLO**

COD. 00129





### Art. 086 *Attica*

- STRUTTURA FAGGIO:  
NATURALE - NOCE CHIARO  
NOCE MEDIO - CILIEGIO - WENGÈ

- **ORDINE MINIMO 20 PZ.**  
TEMPI CIRCA 40 GG.

- SEDILE MASSELLO **COD. 0179**
- SEDILE ECOPELLE **COD. 0179**  
supplemento struttura laccata + € 18,00



### Art. 134 *Italia*

- STRUTTURA FAGGIO:  
NATURALE - NOCE CHIARO  
NOCE MEDIO - CILIEGIO  
TINTE AL CAMPIONE + € 5,00 NETTI

- ECOPELLE COLORI A SCELTA

- **ORDINE MINIMO 40 PZ.**  
TEMPI CIRCA 40 GG.

- **COD. 0096**

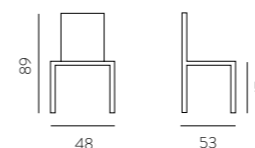

## Art. 084 Croisette

- PILE N. 10 pz.  
apertura pila +10,00 netto
- **NORMALMENTE IN PRONTA CONSEGNA**
- **STRUTTURA FAGGIO EUROPEO**
- TINTO NATURALE / CANNA INTRECCIATA
- TINTO NOCE / ECOPELLE BROWN

COD. 00158

COD. 00158

Tinta noce / Sedile ecopelle custom  
+ 28,00 €



impilabile 10 pz.



## Art. 080 Milano Chair

L43-P51-HS46-HT81

tinta NOCE vedi pag. 182 COD. 00148

laccato VARI COLORI / anilina NERA COD. 00156

laccato BIANCO ANTICATO (SHABBY) COD. 00163

Per quantità tinta campione cliente

■ **ORDINE MINIMO 12 PZ. con acconto**  
**TEMPI 30/40 GG**

sotto 12 pz. costo gestione € 80,00  
(solo tinte / laccate: bianco - nero)

SGABELLO + € 78,00 DAL COSTO SEDIA  
ORDINE MINIMO 6 PZ.



## Patten

sedile legno incassato COD. 00249  
sedile a filo (vedi sedia Milano) COD. 00239  
sedile imbottito COD. 00259

## Sedia Art. 082 Croce

Tinte Legno vedi pag. 182

Tinta Anilina + € 8,00 - Laccato uniforme + € 10,00 - Laccato Shabby + € 18,00

Sedile imbottito ecopelle

■ **ORDINE MINIMO 12 PZ. con acconto**  
**TEMPI 30/40 GG**

sotto 12 pz. costo gestione € 80,00  
(solo tinte / laccate: bianco - nero)

## Stool

**ARCHI**  
sedile legno incassato COD. 00299  
sedile a filo COD. 00289  
sedile imbottito COD. 00309

**PATTEN**  
sedile legno incassato COD. 00308  
sedile a filo COD. 00298  
sedile imbottito COD. 00318



## Archi

sedile legno incassato COD. 00238  
sedile a filo COD. 00228  
sedile imbottito COD. 00248





# STOOLS

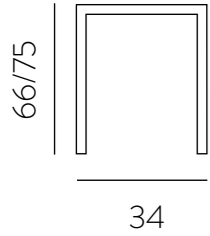

## Tommy Stool

- **IMBALLO N. 4 pz.**  
Imballo speciale 1/3 pz. + 10,00 netto
- **NORMALMENTE IN PRONTA CONSEGNA**
- **POLIPROPILENE RINFORZATO CON FIBERGLASS:**  
bianco - nero - sabbia
- **ART. 526/6 H65** COD. 00114
- **ART. 526/7 H75** COD. 00118

INDOOR / OUTDOOR



## Art. 532/7 Bitter Stool H 77

- **TEMPI 20/30 GG**
- **STRUTTURA METALLO VERNICIATA nero**
- **SEDILE CUSTOM: VELLUTO O ECOPELLE** COD. 00158
- **ART. 532/6 H67** COD. 00158

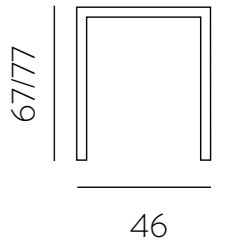



## River Stool

■ **IMBALLO N. 4 pz.** - Imballo speciale 1 pz. + 10,00 netto

■ **NORMALMENTE IN PRONTA CONSEGNA**

■ **STRUTTURA RESINA RINFORZATA CON FIBERGLASS:**

	bianco	sabbia	tortora	antracite	celeste	verde oliva
■ ART. 542/6 H 65	COD. 00128	COD. 00128	COD. 00128	COD. 00128	COD. 00128	COD. 00128
■ ART. 542/7 H 76	COD. 00138	-	COD. 00138	COD. 00138	COD. 00138	COD. 00138

INDOOR / OUTDOOR



## Art. 549/7 - H76 Zerocinquantuno Stools

■ **IMBALLO N. 4 pz.**  
Imballo speciale 1 pz. + 10,00 netto

■ **NORMALMENTE IN PRONTA CONSEGNA**

■ **POLIPROPILENE:** COD. 00146  
antracite - tortora  
grigio chiaro - bianco - senape  
verde oliva - ottanio - fango - cipria



DISPONIBILE ANCHE H 65

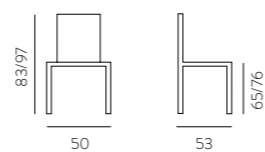

INDOOR / OUTDOOR



bianco  
sabbia eliminato  
tortora  
antracite

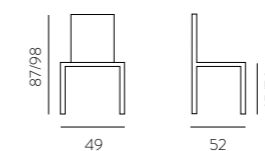



### Art. 529 Alina Stool contract H 80

- **IMBALLO N. 2 pz. TAX** COD. 00196
- **TEMPI 20/30 GG**
- POLIPROPILENE BIANCO PANNA/METALLO BIANCO PANNA
- POLIPROPILENE TORTORA/METALLO BIANCO PANNA
- POLIPROPILENE ANTRACITE/METALLO ANTRACITE
- METALLO CROMATO
- POLIPROPILENE: BIANCO PANNA - TORTORA - ANTRACITE



bianco panna

tortora

antracite

### Art. 527 Alina Stool H 65

- **IMBALLO N. 2 pz.**  
Imballo speciale 1 pz. + 10,00 netto
- **NORMALMENTE IN PRONTA CONSEGNA**
- POLIPROPILENE BIANCO PANNA/METALLO BIANCO PANNA
- POLIPROPILENE TORTORA/METALLO BIANCO PANNA
- POLIPROPILENE ANTRACITE/METALLO ANTRACITE

COD. 00186  
COD. 00186  
COD. 00186

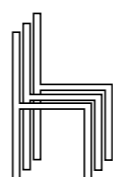
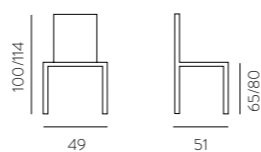

### Ink Stool

- **IMBALLO N. 2 pz.**  
Imballo speciale 1 pz. + 10,00 netto
- **NORMALMENTE IN PRONTA CONSEGNA**
- **STRUTTURA POLICARBONATO TRASPARENTE**
- **Art. 544/6 H 65** COD. 00259
- **Art. 544/7 H 74** COD. 00259

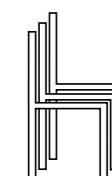
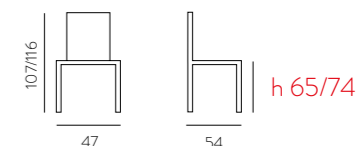



Gli sgabelli presenti nelle foto sono solo decorativi

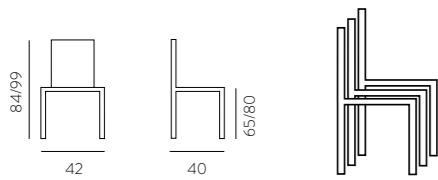

### Art. 557/6 Prisma h 65

- **IMBALLO N. 4 pz.**  
Imballo speciale 1/3 pz. + 10,00 netto
- **NORMALMENTE IN PRONTA CONSEGNA**

STRUTTURA:	CROMATO	BIANCA	TITANIO
▪ <b>SEDILI</b>			
ECOPELLE: <b>bianco</b>	COD. 00259	COD. 00259	-
ECOPELLE: <b>nero</b>	COD. 00259	-	-
ECOPELLE: <b>titanio</b>	-	-	COD. 00259
ECOPELLE SPECIAL (TEMPI 30 GG)	COD. 00339	COD. 00339	COD. 00339
STOFFA CLIENTE 1 MT (TEMPI 30 GG)	COD. 00329	COD. 00329	COD. 00329

### Art. 557/8 Prisma h 80

- **IMBALLO N. 4 pz.**  
Imballo speciale 1/3 pz. + 10,00 netto
- **NORMALMENTE IN PRONTA CONSEGNA**

STRUTTURA:	CROMATO	BIANCA	TITANIO
▪ <b>SEDILI</b>			
ECOPELLE: <b>bianco - nero</b>			COD. 00268
ECOPELLE SPECIAL (TEMPI 30 GG)			COD. 00348
STOFFA CLIENTE 1 MT (TEMPI 30 GG)			COD. 00338

## Art. 1068 bancone **Cameo Break**

- **TEMPI 30 GG**
- **H 105** spessore piani 25 mm

STRUTTURA	P60	P80
L 120	COD. 00380	COD. 00410
L 140	COD. 00395	COD. 00430
L 160	COD. 00420	COD. 00460
L 180	COD. 00440	COD. 00490

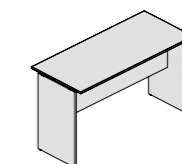

P 60 - H 105

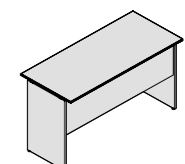

P 80 - H 105



## Art. 506/8 Lulù Stool

- **GAMBE VERNICIATE NERE**  
gamba Ø 22 conificata
- **IMBALLO N. 2 pz.**  
Imballo speciale 1 pz. + 10,00 netto

L53-P52-**HS75**-HT110 COD. 00208

struttura nera / velluto grigio

**NORMALMENTE IN PRONTA CONSEGNA**

### CUSTOM

stoffa cliente COD. 00258  
mt. 1,2 cad.

tessuto cat. B COD. 00290  
ECOPELLE - VELLUTO  
**TEMPI 40 GG.**

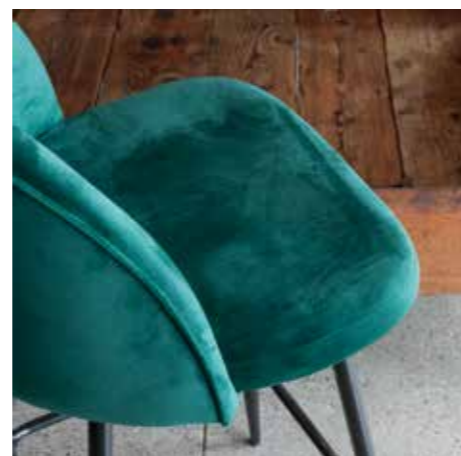

cucitura con PIPING

## Art. 506/6 Lulù Stool H 65

- **VELLUTO: grigio perla - verde bosco** COD. 00196
- **NORMALMENTE IN PRONTA CONSEGNA**



cucitura con PIPING

## OPERA STOOL

- **STRUTTURA METALLO VERNICIATA NERO**  
CON PUNTALI OTTONE GALVANICO

- **VELLUTO: sabbia - grigio fumo**

■ **ART. 568/6 H65** COD. 00268

■ **ART. 568/7 H75** COD. 00278

- **NORMALMENTE IN PRONTA CONSEGNA**

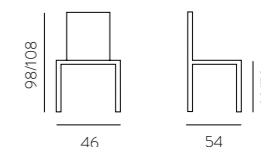

### VERSIONE CUSTOM - 40 GG

- **H65**
- **VELLUTO A CAMPIONARIO** COD. 00390
- **STOFFA CLIENTE (1,5 MT)** COD. 00350

- **H75**
- **VELLUTO A CAMPIONARIO** COD. 00400
- **STOFFA CLIENTE (1,5 MT)** COD. 00360



## Art. 517/8 **Ginger Stool** H 80

VELLUTO:  
grigio fumo - tortora - senape - arancio - blu - verde

- STRUTTURA NERA/VELLUTO NON IGNIFUGO
- **NORMALMENTE IN PRONTA CONSEGNA**
- STRUTTURA OTTONE/VELLUTO NON IGNIFUGO
- (ordine minimo 10 PZ) **TEMPI 40/50 GG** con acconto

COD. 00269

COD. 00359

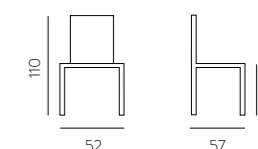

Velluto ignifugo + € 35,00 (ordine min. 10 pz.)

DISPONIBILE ANCHE H 65



accessorio piedino ottone H 8 cm  
+ € 36,00 set 4 pz.



## Norway Stool

- **IMBALLO N. 4 pz.**  
Imballo speciale 1/3 pz. + 10,00 netto

- **NORMALMENTE IN PRONTA CONSEGNA**
- STRUTTURA METALLO VERNICIATA **nero**
- SEDILE RETRO SCHIENALE LISCIO

- **SEDILE**  
ECOPELLE EFFETTO NABUK: beige - grigio

ECOPELLE UNICOLOR:  
titanio - tortora fango - ghiaccio (tortora chiaro) - nera

- ART. **510/2** BASE 4 GAMBE H65 COD. 00276

- ART. **510/3** BASE 4 GAMBE H80 COD. 00289

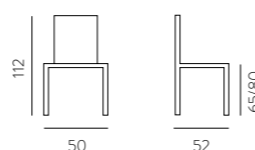
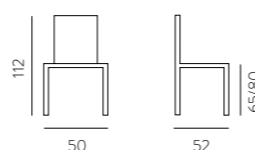



DISPONIBILE ANCHE H 65

Art. 582/8 **Juliette Stool H 80**

struttura verniciata: **NERO** / velluto antimacchia

COD. 00296

**NORMALMENTE IN PRONTA CONSEGNA**

velluto: grigio fumo - celeste - rosa - verde - ottanio - mattone - giallo

Velluto ignifugo + € 35,00 (ordine min. 10 pz.)

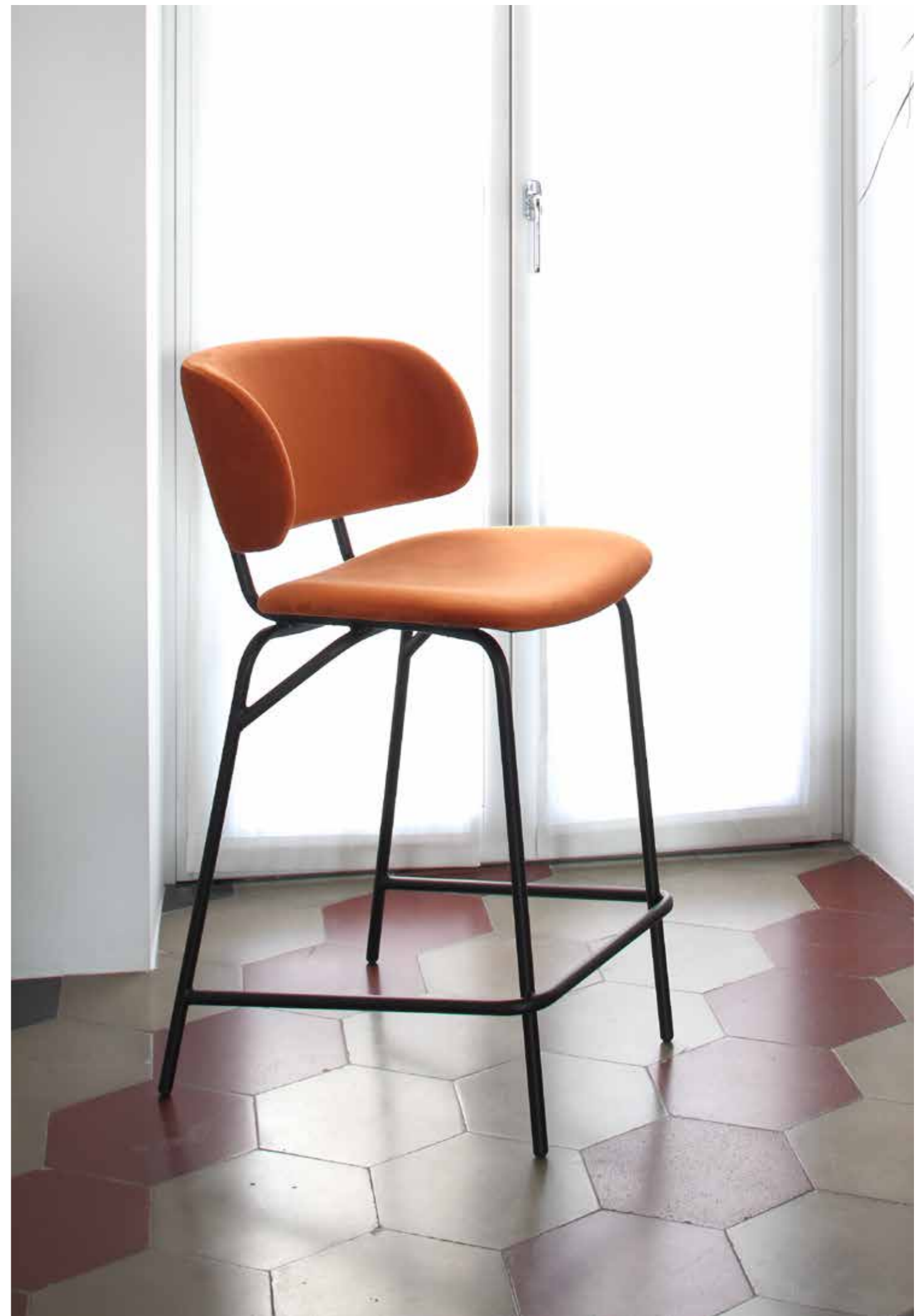
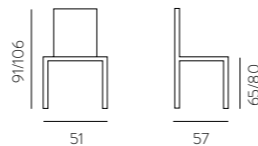



## Dublin Stool

- **IMBALLO N. 4 pz.**  
Imballo speciale 1/3 pz. + 10,00 netto
- **NORMALMENTE IN PRONTA CONSEGNA**
- **STRUTTURA METALLO VERNICIATA nero**
- **SEDILE: ECOPELLE cuoio vissuto cognac**
- **ART. 514/1 BASE SLITTA H65** COD. 00249
- **ART. 514/2 BASE 4 GAMBE H65** COD. 00276
- **ART. 514/3 BASE 4 GAMBE H80** COD. 00289

disponibile solo con  
ecopelle di serie

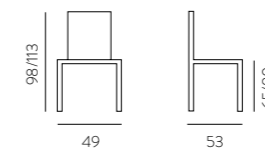

## Cinquecento Stool

- **IMBALLO N. 4 pz.**  
Imballo speciale 1/3 pz. + 10,00 netto
- **NORMALMENTE IN PRONTA CONSEGNA**
- **STRUTTURA METALLO VERNICIATA nero**
- **SEDILE**  
ECOPELLE EFFETTO NABUK:  
beige - grigio
- **ART. 500/1 BASE SLITTA H65** COD. 00249
- **ART. 500/2 BASE 4 GAMBE H65** COD. 00276
- **ART. 500/3 BASE 4 GAMBE H80** COD. 00289

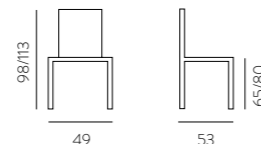

## Hollywood Stool

- **IMBALLO N. 1 pz.**
- **NORMALMENTE IN PRONTA CONSEGNA**
- **STRUTTURA: CROMATO**
- **SEDILI**
  - ECOPELLE GRAFFITI:  
arancio - blu - verde - giallo - rosso
  - SPRINT (BANDA BIANCA): TEMPI 30 GG.  
arancio - blu - verde - giallo - rosso - nero  
bianco/banda nera
  - ITALY FLAG 

Art. 535/6 H60	Art. 535/7 H75
COD. 00286	COD. 00306
COD. 00307	COD. 00327
COD. 00307	COD. 00327

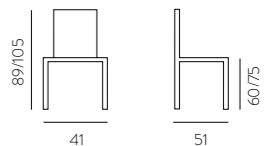





## Route 66 Stool

■ **NORMALMENTE IN PRONTA CONSEGNA**

■ **IMBALLO N. 4 pz.**  
Imballo speciale 1/3 pz. + 10,00 netto

- **Art. 590/6 H65:**
  - COUNTRY CHIC (BIANCO ANTICATO) COD. 00128
  - BRUNITO COD. 00128
  - NATURALE PROTETTO DA VERNICE TRASPARENTE COD. 00128
  - NERO OPACO COD. 00108
- **Art. 590/7 H74:**
  - COUNTRY CHIC (BIANCO ANTICATO) COD. 00134
  - BRUNITO COD. 00134
  - NATURALE PROTETTO DA VERNICE TRASPARENTE COD. 00134
  - NERO OPACO COD. 00108

## Route 66 Back Stool

■ **IMBALLO N. 4 pz.**  
Imballo speciale 1/3 pz. + 10,00 netto

- **Art. 592/6 H65:**
  - COUNTRY CHIC (BIANCO ANTICATO) COD. 0133
  - BRUNITO COD. 0133
- **Art. 592/7 H74:**
  - COUNTRY CHIC (BIANCO ANTICATO) COD. 0139

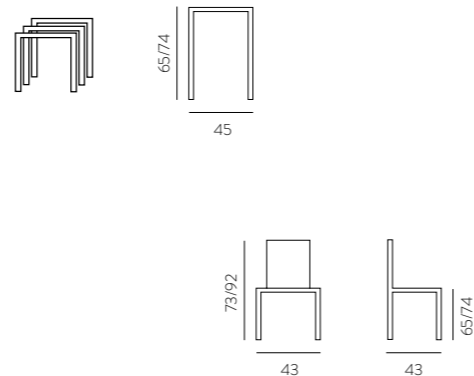

## Giotto

- **IMBALLO N. 1 pz.**
- **NORMALMENTE IN PRONTA CONSEGNA**
- **STRUTTURA FAGGIO NATURALE**  
PARTICOLARI POLIPROPILENE **nero**
- **Art. 508/4** DA H 42 A 55 COD. 00158
- **Art. 508/6** DA H 67 A 80 COD. 00189

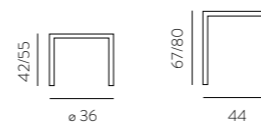

## Art. 580 Urban

- **IMBALLO N. 1 pz.**
- **NORMALMENTE IN PRONTA CONSEGNA**
- **STRUTTURA METALLO**  
VERNICIATA NERO INDUSTRIAL
- **SEDILO LEGNO NOCE INDUSTRIAL** COD. 00186

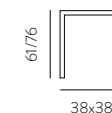



## Art. 584 Jordan

■ **IMBALLO N. 2 pz.**  
Imballo speciale 1 pz. + 10,00 netto

■ **NORMALMENTE IN PRONTA CONSEGNA**

■ **STRUTTURA:** NERA

■ **SEDILI**  
POLIPROPILENE NERO / ECOPELLE nero COD. 00136

POLIPROPILENE NERO / VELLUTO CUSTOM: COD. 00168  
ottanio - verde - giallo - mattone - grigio fumo - tortora

RICAMBI: guarnizione sottobase (tipo grande) COD. 0019 - pistone COD. 0036

■ **USO DOMESTICO, NON GARANTITO PER LOCALE PUBBLICO**

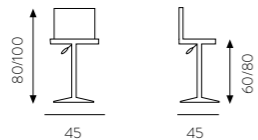

## Art. 575 Maxim

■ **IMBALLO N. 1 pz.**

■ **NORMALMENTE IN PRONTA CONSEGNA**

■ **STRUTTURA:** CROMATO

■ **SEDILE SCHIUMATO**  
ECOPELLE: bianco - nero - titanio COD. 00436

ECOPELLE SPECIAL (TEMPI 30 GG) COD. 00536

ECOPELLE CLIENTE: 1 mt (TEMPI 30 GG) COD. 00508

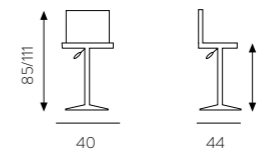



**\*\* Art. 550 Fruit**

■ POLIPROPILENE/ECOPELLE:

bianco-arancio-rosso-verde-nero-grigio chiaro

COD. 00136

**NORMALMENTE IN PRONTA CONSEGNA**

**\*\* Art. 574 Jazz**

ECOPELLE: bianco - nero - tortora chiaro  
COD. 00188

**NB: NON CONSIGLIATI E GARANTITI PER USO INTENSIVO \*\***



**Art. 462 Bit**

aperta: L45-P51-HS43-HT77 - chiusa: 91x3

■ STRUTTURA VERNICIATA IN TINTA / POLIPROPILENE: COD. 0068

bianco - nero - brown

**Art. 463 Bit lux**

■ STRUTTURA CROMATA / POLIPROPILENE TRASLUCIDO COD. 0089



**Art. 481/CA Carrello**

38x50xh119 COD. 00128



**Art. 481/G Gancio**

L 40 - P 21 COD. 0064



**NORMALMENTE IN PRONTA CONSEGNA**



# Art. 468 Dreen

■ POLIPROPILENE:

bianco - antracite - sabbia - verde

COD. 00106

DESIGN E ROBUSTEZZA  
ADATTA ANCHE PER  
OUTDOOR

aperta: L48 - P52 - HS45 - HT82  
chiusa: 94x11

**NORMALMENTE IN PRONTA CONSEGNA**

INDOOR / OUTDOOR



Art. 481/CA Carrello  
38x50xh119 COD. 00128

Art. 481/G Gancio  
L 40 - P 21 COD. 0064





## Art. 436 Fellini

L56 - P54 - HS45 - HT85  
chiuso/close L18 - P54 - H85

<b>148,00</b>	<b>SOLO STRUTTURA</b> FAGGIO TINTO: NATURALE-NOCE-MOGANO-ANILINA NERA NB: AGGIUNGERE COSTO COPPIE TELE
---------------	--

<b>168,00</b>	<b>VERSIONE PLUS</b> SOLO STRUTTURA NB: AGGIUNGERE COSTO COPPIE TELE
---------------	---

435/3	COPPIE TELE NORMALI PER CIAK-FELLINI	29,00	TELA <b>COTONE ECRÙ</b> TELA <b>ACRILICA</b> : NATURALE-BIANCO OTTICO NERO-CAFFÈ-ROSSO-BORDEAUX VERDE BOTTIGLIA-BLU
435/4	COPPIE TELE TRAPUNTATE PER CIAK-FELLINI	56,00	TELA <b>COTONE ECRÙ</b> TELA <b>ACRILICA</b> : NATURALE-BIANCO OTTICO NERO-CAFFÈ-ROSSO-BORDEAUX VERDE BOTTIGLIA-BLU
435/5	COPPIE TELE PVC RETINO PER CIAK-FELLINI per outdoor	44,00	BIANCO OTTICO-BIANCO CREMA-NERO ROSSO-BORDEAUX-BLU-GIALLO

PRODOTTO CEE  
ordine min 20 pz.  
anche assortiti

INDOOR / OUTDOOR



## Art. 435/1 Ciak

L59 - P44 - HS45 - HB69 - HT89  
chiuso/close L17 - P44 - H113

<b>168,00</b>	<b>SOLO STRUTTURA</b> FAGGIO TINTO: NATURALE-NOCE-MOGANO-ANILINA NERA NB: AGGIUNGERE COSTO COPPIE TELE
---------------	--

## Art. 435/2 Ciak Stool

L59 - P50 - **HS65/75** - HB89/99 - HT109/119  
chiuso/close L17 - P50 - H127/137

<b>196,00</b>	<b>SOLO STRUTTURA</b> HS. 65 / 75 FAGGIO TINTO: NATURALE-NOCE-MOGANO-ANILINA NERA NB: AGGIUNGERE COSTO COPPIE TELE
---------------	--



# OUTDOOR



## Serie OUT LIGHT

alimentati a cavo - norme CEE

tempi circa 40 gg.

### Art. 1798 Barman



Sgabello h.75 Armin Stool

#### 1798 Barman

BANCO/DESK MULTIUSO in polipropilene, completo di piedini regolabili

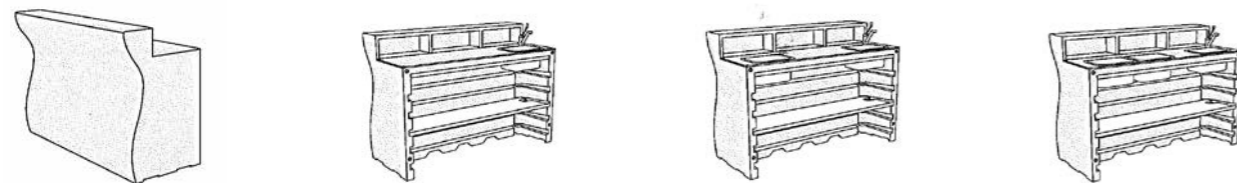

**MODULO BASE**  
bianco C2 cod. 6277  
neutro 98 cod. 8277  
**1.760,00**

con piano alimentare  
lavandino inox  
piletta di scarico  
rubinetto

mensola con foro  
bianco C2 cod. 6286  
neutro 98 cod. 8286  
**3.760,00**

con piano alimentare  
lavandino inox  
piletta di scarico  
rubinetto

mensola con foro  
ghiacciaia in inox  
bianco C2 cod. 6287 **4.090,00**  
neutro 98 cod. 8287

con piano alimentare  
lavandino inox  
piletta di scarico  
rubinetto

mensola con foro  
2 ghiacciaie in inox  
bianco C2 cod. 6288 **4.430,00**  
neutro 98 cod. 8288

kit luce outdoor cod. A4182 (applicabile solo nella versione neutra 98, 1/3 per modulo - 1 per angolo) **170,00 cad.** **ARMIN STOOL** cod. 6249

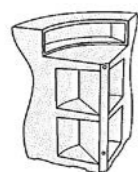

**890,00**  
bianco C2 cod. 6278  
neutro 98 cod. 8278

#### OPTIONALS



**PIANO TOP** cod. A4400 **380,00**  
**KIT MENSOLA** cod. A4405 **530,00**



**TOP ANGOLO**  
cod. A4406 **390,00**



**KIT RUOTE**  
4 ruote, 2 con freno  
cod. A4409 **45,00**



**265,00**  
bianco C2  
tortora G9  
nero perla 87

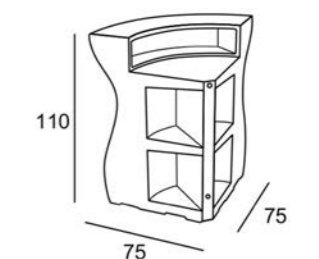
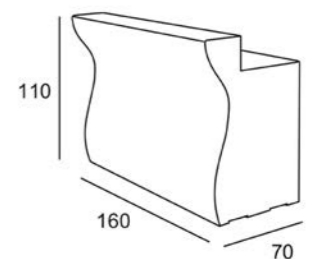



Art. 1800/5 vaso conico tondo light  
 Ø 42-H 90 sub.2666 **668,00**  
 Ø 57-H 126 sub.2674 **996,00**



Art. 1800/4 vaso conico quadro light  
 35 x 35 H 75 sub. 2694 **546,00**  
 40 x 40 H 90 sub. 2698 **692,00**

## Serie OUT LIGHT

alimentati a cavo - norme CEE  
 tempi circa 30 gg.



Art. 1800/1 Cubi Light  
 40 x 40 H 40 sub. 2706 **396,00**  
 50 x 50 H 50 sub. 2709 **487,00**



Art. 1800/3 Vasi Light  
 40 x 40 H 70 sub. 2742 **654,00**  
 80 x 30 H 70 sub. 2746 **828,00**  
 100 x 40 H 70 sub. 2702 **972,00**



## Art. 1800/10 Stone-P

poltrona L 92 x P 86 x HT 65 - HS 39

<b>576,00</b>	BIANCO
<b>736,00</b>	NEUTRO con kit luce



## Art. 1800/12 Stone-T

tavolino contenitore Ø 77 x H 33

<b>566,00</b>	BIANCO C2-TORTORA G9 (fuxia eliminato) colori top: BIANCO C2-TORTORA G9 NERO PERLA 87 (non adatto ad esposizione raggi solari)
---------------	--

## Art. 1800/11 Stone-D

divanetto L 165 x P 88 x HT 66 - HS 39

<b>1.387,00</b>	BIANCO (fuxia eliminato)
<b>1.690,00</b>	NEUTRO con kit luce



Import **qualità garantita, consegna veloce, misure e colori fissi**  
per modelli **CUSTOM**, vedi PDF Ombrelloni Hand Made  
richiesta via mail a: [commerciale@laseggiola.it](mailto:commerciale@laseggiola.it)

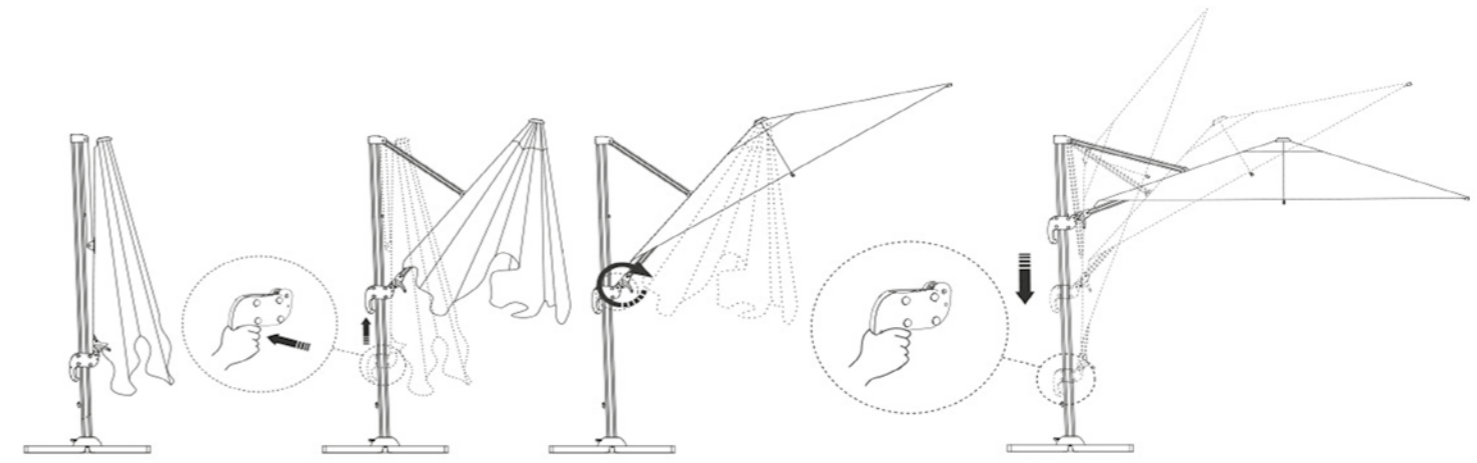

tutto alluminio  
(apertura a manovella - girevole a 360°  
dotato di sistema regolazione inclinazione)



## Art. 1827/1 **Tremiti**

disponibile solo: verniciato **antracite** / telo **beige**

**3 mt x 3 mt** COD. 001470 (6 piastre)

**4 mt x 3 mt** COD. 001680 (8 piastre)

N.B. piastre di stabilizzazione comprese

**NORMALMENTE IN PRONTA CONSEGNA**

fino a esaurimento scorte stagionali



Verricello per chiusura  
e maniglione per regolazione in-  
clinazione



Pedale frizione per la rotazione 180°







## BASI per **OUTDOOR**



Nota bene: per le forniture contract di prodotti non in pronta consegna verrà richiesto un acconto

adatte per zone marine  
spiagge, ecc.



## Basi **NETTUNO**

**ALLUMINIO**

Colori: bianco - antracite

fissa h73 Art. 1411.5060/BF  
fissa h109 Art. 1411.5065/AF

COD. 00198  
COD. 00239

**TEMPI 20/30 gg**

chiudibile bassa h73 Art. 1411.5070/BP  
chiudibile alta h109 Art. 1411.5075/AP

COD. 00228  
COD. 00279

**NORMALMENTE IN PRONTA CONSEGNA**

**NB: aggiungere piano, vedi HPL**



## Basi **TROLL**

**ALLUMINIO**  
(con zavorra e piedini regolabili)  
verniciata **NERO**

fissa h73 Art. 1740/1  
fissa h109 Art. 1740/2

COD. 00127  
COD. 00139

chiudibile bassa h73 Art. 1750/1  
chiudibile alta h108 Art. 1750/2

COD. 00147  
COD. 00159

**NORMALMENTE IN PRONTA CONSEGNA**

**NB: aggiungere piano, vedi HPL**



adatte per zone marine  
spiagge, ecc.



## BASE mod. RIMINI ALLUMINIO PER ZONE SALINE O ALTO TASSO DI UMIDITÀ

Base in acciaio verniciato (zavorra), con cover alluminio  
Tubo 8x8 in alluminio verniciato

H 72 Art. 1760  
40x40-H72 verniciata nera  
per piani max 90x90

COD. 00139

H 108 Art. 1762  
40x40-H72 verniciata nera  
per piani max 70x70

COD. 00169

Piedino regolabile

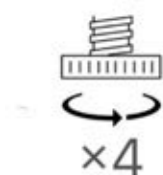

DISPONIBILE DA  
NOVEMBRE 23



Base Art. 1053 **Spritz** COD. 00108

**NORMALMENTE IN PRONTA CONSEGNA**

metallo verniciato **nero**

per piani max 70x70  
uso bar/gelateria

NO ristorazione



Art. 1779/..... **Base Croce**

Base a croce 55x55 in ghisa verniciata  
colonna quadra 5x5 in acciaio zincato  
Il tutto verniciato per esterno  
completo di piedini regolabili

disponibile nei colori: **bianco - antracite**

Art. 1779 /1 H73 per piani max 80x80 COD. 00158  
Art. 1779 /2 H109 per piani max 70x70 COD. 00178

**NORMALMENTE IN PRONTA CONSEGNA**

**Mosaico basi per esterno USO DEHOR** vedi da pag. 10 a 19  
non adatte per ambienti estremamente umidi, zone saline, spiagge (vedi base mod. Rimini)



Art. 1032 **Piatta nera**

Art. 1032 **Piatta bianca**

Art. 1031 **Piramide**

Art. 1046 **Como**

Art. 1052 **Impero**

Art. 1043 **Bistrot**

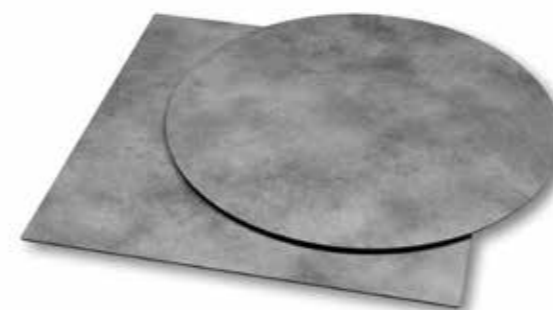

 spessore 10 mm

**BASI**  
per **OUTDOOR**

**Piani HPL** vedi pag. 22-23





## PIANI per **OUTDOOR**



### Art. 1100TE Piano Teak

**NORMALMENTE IN PRONTA CONSEGNA**

Fino ad esaurimento scorte stagionali.

**Teak massello** (vero teak indonesiano)

70 x 70 COD. 00178

80 x 80 COD. 00196

Ø 70 COD. 00169

Optional applicazione bussole antistrappo (con vite brugola)  
+ € 8,00 netti consigliabile solo per basi in ghisa



\*Art. 1771  
**Allumix Impy**  
Ø 60 - H72  
COD. 0098  
gambe alluminio  
top inox bulinato

\*Art. 1769 **Allumix Table**  
Ø 70 - H72 COD. 0098  
base alluminio  
top inox bulinato

Art. 014 **Vela** COD. 0087

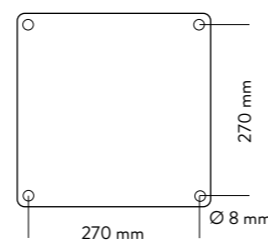

Poltroncina 013 **Vivian** COD. 0096

## piani **MONTECARLO**

Listelli resina effetto wood, tinta teak - spessore 18 mm

**NB: NO MANUTENZIONE fine stagione**

Sotto struttura metallo con trattamento elettrolitico antiruggine,  
verniciata polvere doppio passaggio

TOP 70x70 Art. 1204 COD. 00176

TOP 80x80 Art. 1204 COD. 00198

predisposto per basi con piastre G02 (interasse 270 mm.)

**DISPONIBILI DA MARZO 2024**



\*Art. 1772 **Allumix Stool**  
L53-P53-HS77-HT101 COD. 00128  
alluminio

**\* NORMALMENTE IN PRONTA CONSEGNA**  
(fino ad esaurimento scorte stagionali)



Poltroncina Art. 1126 Atlantica

## Art. 1808 Metal Quadro

tavolo accatastabile per outdoor  
AUTOLIVELLANTE

Tavolo metallo 4 gambe saldate con trattamento per esterno verniciato: **BIANCO - ANTRACITE - NERO**

**NORMALMENTE IN PRONTA CONSEGNA**

NELLE MISURE:

70x70 COD. 00330  
80x80 COD. 00345

realizzabile anche altre misure (ordine min 5 pz. - tempi in stagione 50/60 gg) a preventivo, richiesta a: [commerciale@laseggiola.it](mailto:commerciale@laseggiola.it)

■ BANCALE DA 16 pz. - Imballo speciale 1/6 pz. + 20,00 netto - Imballo speciale 7/15 pz. + 10,00 netto



accatastabile

## TAVOLI per OUTDOOR



Sedia Aster Rope





Celeste

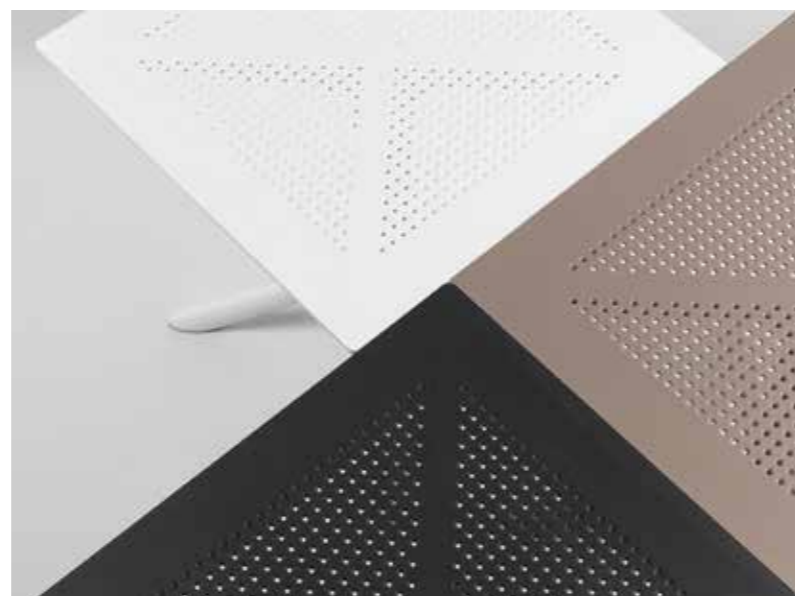

## Tavolo Art. 1252 **Clipper**

tutto polipropilene,  
canotto rinforzato per uso ristorante / pizzeria  
colori: bianco - antracite - tortora

piano 70x70 COD. 00288

piano 80x80 COD. 00296

**IN STAGIONE TEMPI 30/40 GG.**

totalmente resistente per esterni  
sedie consigliate: **Boreale - River**



## Boreale

COLORI: bianco - antracite - tortora - celeste

Sedia Art. 1250/5S \* COD. 00109  
L43-P52-HS46-HT83

Poltroncina Art. 1250/5P \* COD. 00118  
L58-P55-HS46-HB66-HT86

- IMBALLO N. 4 pz.  
Imballo speciale 1/3 pz. + 10,00 netto

\* **NORMALMENTE IN PRONTA CONSEGNA**

Sgabello Art. 1250/SG COD. 00136  
L49-P52 - altezza seduta: 65 oppure 76

- IMBALLO N. 4 pz. TAX **TEMPI 30/40 GG**



Nota bene: per le forniture contract di prodotti  
non in pronta consegna verrà richiesto un acconto



## Art. 1797/1 Parisienne

- RESINA EFFETTO WICKER:  
bianco - nero - tortora

COD. 0079



- PILE N. 22 pz. - **ORDINI A MULTIPLI DI 22 / ORDINE MIN. 2 PILE**  
TEMPI 20/30 GG.

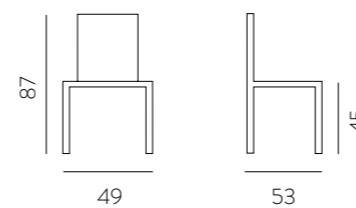



■ RESINA RINFORZATA CON FIBERGLASS:  
bianco - nero - tortora

■ IMBALLO N. 4 pz.  
Imballo speciale 1/3 pz. + 10,00 netto

**NORMALMENTE IN PRONTA CONSEGNA**

Sedia 012 Penny COD. 0087

**ORDINI A STOCK**

■ IMBALLO A PILE N. 23 pz. monocolore  
ordini 2/3 pile COD. 0081  
ordini 4 pile in su COD. 0076

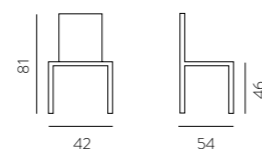

Poltroncina 013 Vivian COD. 0096

**ORDINI A STOCK**

■ IMBALLO A PILE N. 23 pz. monocolore  
ordini 2/3 pile COD. 0089  
ordini 4 pile in su COD. 0082

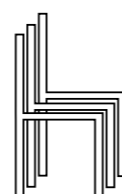
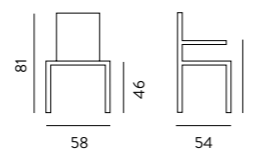



## Art. 070 Parigi

■ **IMBALLO PILE N. 24 pz. monocolore**  
apertura imballo + 10,00 netto

■ **NORMALMENTE IN PRONTA CONSEGNA**

■ **RESINA RINFORZATA CON FIBERGLASS:**  
**bianco - nero - sabbia** COD. 00108

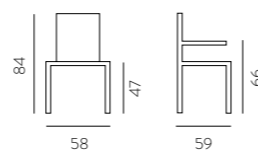

**TOP QUALITY**



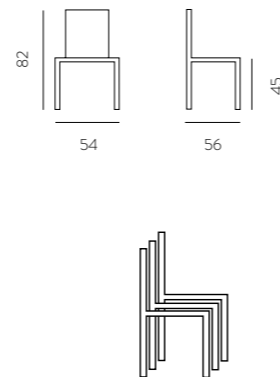

## Art. 08 Pilar

- IMBALLO N. 4 pz.
- **NORMALMENTE IN PRONTA CONSEGNA**

- POLIPROPILENE: COD. 00126  
bianco - sabbia - antracite

NB: nel colore antracite sono presenti i leggeri segni dello stampaggio



Base non disponibile vedi Art. 1779 Croce

## Art. 043 Aurea

L57-P55-HS48-HT77

struttura polipropilene **nero** COD. 00136  
scocca polipropilene vari colori

accessorio cuscinetto COD. 0048  
velluto o ecopelle

- IMBALLO N. 4 pz. monocolori  
**TEMPI 30 GG.**  
**NB: ordine min 20 pz. con acconto**





## 1126 Atlantica COD. 00156

L57-P62-HS44-HT90

- PILE N. 24 pz. - apertura pila +10,00 netto
- **NORMALMENTE IN PRONTA CONSEGNA**
- STRUTTURA POLIPROPILENE:  
bianca / retina textilene bianca  
tortora / retina textilene tortora  
antracite / retina textilene nera

con retina top quality

**Serge Ferrari**  
group

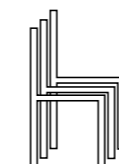



## 1126 Atlantica

COD. 00156

L57-P62-HS44-HT90

- PILE N. 24 pz. - apertura pila +10,00 netto
- **NORMALMENTE IN PRONTA CONSEGNA**
- STRUTTURA POLIPROPILENE:  
bianca / retina textilene bianca  
tortora / retina textilene tortora  
antracite / retina textilene nera

con retina top quality

**Serge Ferrari**  
group

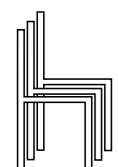
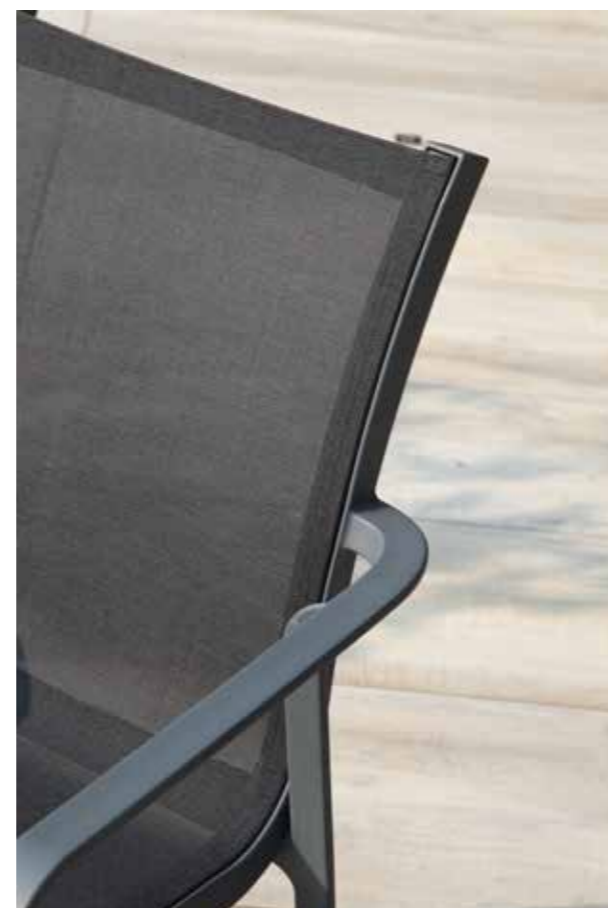



## Art. 078 Borgo Antico

- **IMBALLO PILE N. 14 pz. monocolore**  
apertura imballo + 10,00 netto
- **NORMALMENTE IN PRONTA CONSEGNA**
- **RESINA RINFORZATA CON FIBERGLASS:**  
**bianco - sabbia** COD. 0099

**TOP QUALITY**

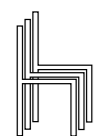

impilabile



# IL BANQUETING

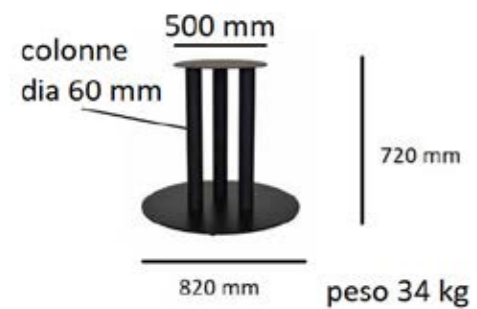

Art. 1035 **Big Round** COD. 00290  
verniciata nera  
per piani max Ø180

Art. 074 **CHIAVARINA**

- RESINA: bianco - tortora - nera
- ORDINE MIN. 50 PZ.

COD. 0089



Art. 072 **NAPOLEON**

- RESINA: bianco - tortora - nera
- ORDINE MIN. 50 PZ.

COD. 0089





# linea MONTECARLO

Struttura metallo Ø 19 mm con trattamento elettroforesi antiruggine, verniciata polvere doppio passaggio

Sedile e schienale resina effetto wood, tinta teak spessore 18 mm - **NB: NO MANUTENZIONE fine stagione**

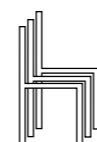

SEDIA Art. 1200

COD. 00186

POLTRONCINA Art. 1202

COD. 00198

DISPONIBILI DA  
MARZO 2024

TOP 70x70 Art. 1204

COD. 00176

TOP 80x80 Art. 1204

COD. 00198

predisposto per basi con piastre  
G02 (interasse 270 mm.)





Art. 1805/2PR COD. 00272

**Poltroncina quadra**

L54-P58-HT84

Imballo 4 pz.

Art. 1805/2SE COD. 00248

**Sedia quadra**

L46-P58-HT84

Imballo 4 pz.



Art. 1805/26 COD. 00156

**Sgabellino quadro**

L37-P37-HT43

Imballo 4 pz.

**TEMPI 20/30 GG.**

Art. 1805/23 **Tavolo quadro** gamba 4x4 - Imballo 1 pz.

60x80 COD. 00428 - 70x70 COD. 00439 - 80x80 COD. 00448 - 90x90 COD. 00489 - 120x80 COD. 00499 - 160x80 COD. 00647

## Linea OUT-METAL

Acciaio zincato e verniciato poliestere per esterni

Tavoli stessa verniciatura sedie/sgabelli.

Per pronta consegna e prezzo lancio

vedi Art. 1808 Metal Quadro pag. 198

Art. 1805/24

**Tavolo quadro snack**

piano H 105 - Imb. 1 pz.

60x80 COD. 00587

80x80 COD. 00628

120x80 COD. 00688

Art. 1805/25

**Panca quadra**

Imb. 2 pz.

107x39x H 45 COD. 00327

113x45x H 75 COD. 00386

Art. 1805/2SG

**Sgabello alto**

Imb. 2 pz. COD. 00289

L46-P50-HT106-HS75



## Linea SUNSHINE

Acciaio zincato e verniciato poliestere per esterni:

bianco VB - antracite VA - tortora VT

celeste VZ - verdino VV

Imballo 2 pz. TAX - **TEMPI 20/30 GG.**

**Sedia**

Art. 1810.2522

L52-P57-HS47-HT80

COD. 00229 con cuscino

COD. 00204 senza cuscino

**Poltroncina**

Art. 1810.2520

L57-P57-HS47-HT80

COD. 00278 con cuscino

COD. 00253 senza cuscino

**Sgabello**

Art. 1810.2535

L47-P49-HS75-HT96

COD. 00286 con cuscino

COD. 00261 senza cuscino



cuscino cotone ecru





Art. 1814/1 **Aster Metal**

Sedia metallo impilabile  
verniciatura e trattamento per esterno - verniciata **nera** COD. 00118

**NORMALMENTE IN PRONTA CONSEGNA**

Per quantità realizzabile colori RAL

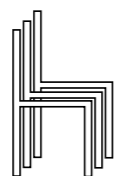

Art. 1790/1 **Jakarta Bambù Look**

struttura alluminio ricoperta PVC effetto bambù COD. 00128

**NORMALMENTE IN PRONTA CONSEGNA**  
(fino ad esaurimento scorte stagionali)

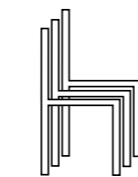

mod **Aster Rope**

Sedia metallo impilabile  
verniciatura e trattamento per esterno **nero**

Per quantità realizzabile colori RAL

**SENZA BRACCIOLI** Art. 1816/1 COD. 00198  
**NORMALMENTE IN PRONTA CONSEGNA**

**CON BRACCIOLI** NON DISPONIBILE







## mod Café de Paris

intreccio corda piatta **tortora**  
struttura metallo zincato **antracite**

**NORMALMENTE IN PRONTA CONSEGNA**  
(fino ad esaurimento scorte stagionali)

### Poltroncina impilabile Art. 1823/15

L60-P55-H79  
scatole da 4

COD. 00256

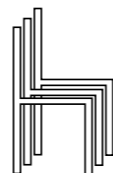

### Sgabello impilabile Art. 1823/17

L58-P50-HS75-HT98 COD. 00296



Poltroncina impilabile  
Art. 1823/14 Biarritz

treccia poliestere (interno gomma) **antracite**  
struttura metallo zincato **antracite**

L57-P56-H81 COD. 00296  
scatole da 4

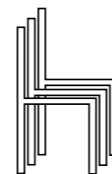

base foto non disponibile, vedi Art. 1053 Spritz





Art. 1823/2 **Nice Stool** COD. 00394

L53-P49-HS75-HT98

- struttura ANTRACITE / intreccio BROWN



Art. 1823/1 **Poltroncina Nice black**

L57-P63-HS45-H76

COD. 00379

intreccio corda poliestere interno gomma  
cuscineria gomma idrofuga / tessuto acrilico **ANTRACITE**  
struttura alluminio verniciata **NERA**

pile da 10 pz., IMBALLO speciale 1/6 € 10,00 netti

**NORMALMENTE IN PRONTA CONSEGNA**

(fino ad esaurimento scorte stagionali)

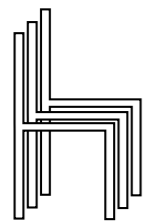



## Art. 1823/40 Poltroncina Taormina

intreccio corda poliestere  
cuscineria gomma idrofuga / tessuto acrilico **GRIGIO**  
struttura alluminio verniciata **BIANCA**

COD. 00360

L57-P59-HS45-H76  
pile da 12 pz., IMBALLO speciale 1/6 € 10,00 netti

**NORMALMENTE IN PRONTA CONSEGNA**  
(fino ad esaurimento scorte stagionali)

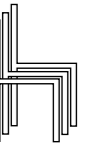



Art. 1823/1 **Poltroncina Nice brown**

L57-P63-HS45-H76

COD. 00379

intreccio corda poliestere interno gomma  
 cuscineria gomma idrofuga / tessuto acrilico **BROWN**  
 struttura alluminio verniciata **ANTRACITE**

pile da 10 pz., IMBALLO speciale 1/6 € 10,00 netti

**NORMALMENTE IN PRONTA CONSEGNA**

(fino ad esaurimento scorte stagionali)



Art. 1823/2 **Nice Stool**

COD. 00394

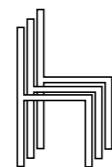



**Poltrona**  
**Art. 1823/3 NICE POLTRONA**  
 L80-P79-HT70  
 COD. 00970  
 Imballo 2 pz.  
 Imballo singolo + € 20,00 netti

**Divano 3 posti (2 cuscini)**  
**Art. 1823/4 NICE DIVANO**  
 L165-P79-HT70  
 COD. 001780

**Tavolino rettangolare**  
**Art. 1823/5 NICE TAVOLINO**  
 L110-P60-H42  
 COD. 00340

## Nice Sofà

intreccio corda poliestere interno gomma  
 cuscineria gomma idrofuga / tessuto acrilico **BROWN**  
 struttura alluminio verniciata **ANTRACITE**

**NORMALMENTE IN PRONTA CONSEGNA**  
 (fino ad esaurimento scorte stagionali)



**Tavolino**  
**Art. 1823/20 Corinto Antracite**  
 verniciato antracite  
 70x56-H37 COD. 00270  
 100x70-H34 COD. 00360





**Divano 3 posti (2 cuscini)** COD. 001780

Art. 1823/30 SOLARIS DIVANO

L165-P79-HT70

**Poltrona** COD. 00970

Art. 1823/31 SOLARIS POLTRONA

L80-P79-HT70

**Tavolino**

Art. 1823/32 **Corinto Black**

verniciato nero

55x45-H40

COD. 00190

70x56-H37

COD. 00270

100x70-H34

COD. 00360



## Solaris Sofà

intreccio corda poliestere interno gomma

cuscineria gomma idrofuga / tessuto acrilico **ANTRACITE**

struttura alluminio verniciata **NERA**

**NORMALMENTE IN PRONTA CONSEGNA**

(fino ad esaurimento scorte stagionali)



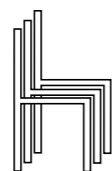

**Poltrona**  
Art. 1823/41  
L80-P79-HT75  
COD. 00890

**Tavolino**  
Art. 1823/20 **Corinto White**  
100x70-H34 COD. 00360

**Divano 3 posti (2 cuscini)**  
Art. 1823/42  
L160-P79-HT75  
COD. 001380

**Poltroncina da tavolo**  
Art. 1823/40  
L57-P59-HS45-H76  
COD. 00360  
pile da 12

## Serie Taormina

intreccio corda poliestere  
cuscineria gomma idrofuga / tessuto acrilico **GRIGIO**  
struttura alluminio verniciata **BIANCA**

**NORMALMENTE IN PRONTA CONSEGNA**  
(fino ad esaurimento scorte stagionali)





## Set OLYMPUS

SOLO SET COMPLETO COMPOSTO DA:  
SOFÀ 2 / 3 POSTI + 2 POLTRONE + 1 TAVOLINO

ANTRACITE / CUSCINI GRIGI

**NORMALMENTE IN PRONTA CONSEGNA**

(fino ad esaurimento scorte stagionali)

set sofà 2 posti **4.090,00**  
Art. 1822/2 Set Olympus 2 posti

DIVANO L137-P80-H71  
POLTRONA L76-P80-H71  
TAVOLINO L90-P55-H36

set sofà 3 posti **4.480,00**  
Art. 1822/3 Set Olympus 3 posti

DIVANO L178-P80-H71  
POLTRONA L76-P80-H71  
TAVOLINO L90-P55-H36



### Divanetto

Art. 1824/11 COUCH DIVANO

COD. 002080

L151-P83-HT72

### Poltrona

Art. 1824/10 COUCH POLTRONA

COD. 001390

L86-P83-HT71

### Tavolino

Art. 1824/13 COUCH TAVOLINO

COD. 00590

piano alluminio verniciato:

**TORTORA** intreccio tortora - **GRIGIO** intreccio antracite

L66-P66-H38



## Couch

stoffa per esterni:

**TORTORA** intreccio tortora - **GRIGIO** intreccio antracite

gomma idrofuga per esterni / struttura alluminio

**NORMALMENTE IN PRONTA CONSEGNA**

(fino ad esaurimento scorte stagionali)



### Divanetto

Art. 1824/11 COUCH DIVANO

COD. 002080

L151-P83-HT72

### Poltrona

Art. 1824/10 COUCH POLTRONA

COD. 001390

L86-P83-HT71

### Tavolino

Art. 1824/13 COUCH TAVOLINO

COD. 00590

piano alluminio verniciato:

**TORTORA** intreccio tortora - **GRIGIO** intreccio antracite  
L66-P66-H38



## Couch

stoffa per esterni:

**TORTORA** intreccio tortora - **GRIGIO** intreccio antracite

gomma idrofuga per esterni / struttura alluminio

**NORMALMENTE IN PRONTA CONSEGNA**

(fino ad esaurimento scorte stagionali)



## Couch Bed

stoffa per esterni:

**TORTORA** intreccio tortora - **GRIGIO** intreccio antracite  
gomma idrofuga per esterni / struttura alluminio

**NORMALMENTE IN PRONTA CONSEGNA**

(fino ad esaurimento scorte stagionali)



### Lettino

Art. 1824/15 COUCH BED  
L190-P82-H36

COD. 001690



Art. 1823/12 **Nice Bed**

L200 - P70 - H37/93 - schienale 4 posizioni  
COD. 001390

intreccio corda poliestere interno gomma  
cuscineria gomma idrofuga / tessuto acrilico **BROWN**  
struttura alluminio verniciata **ANTRACITE**



**NORMALMENTE IN PRONTA CONSEGNA**  
(fino ad esaurimento scorte stagionali)



**Tavolino**  
Art. 1823/20 **Corinto Antracite**  
verniciato antracite  
70x56-H37 COD. 00270  
100x70-H34 COD. 00360



Art. 1823/35 **Solaris Bed**

L200 - P70 - H37/93 - schienale 4 posizioni  
COD. 001390

**NORMALMENTE IN PRONTA CONSEGNA**  
(fino ad esaurimento scorte stagionali)

**Tavolino**  
Art. 1823/32 **Corinto Black**  
verniciato nero  
55x45-H40 COD. 00190  
70x56-H37 COD. 00270  
100x70-H34 COD. 00360





**Lettino Art. 1824/18 Plano** COD. 001680

L203-P90-HS38-HT60 - - schienale 4 posizioni

STRUTTURA IN ALLUMINIO VERNICIATA **ANTRACITE**

CON GOMMA DRENANTE FAST DRY FOAM,  
RIVESTIMENTO TESSUTO SUMBRELLA® **GRIGIO CIELO**

**NORMALMENTE IN PRONTA CONSEGNA**

(fino ad esaurimento scorte stagionali)



**Tavolino**  
Art. 1823/20 **Corinto Antracite**  
verniciato antracite  
70x56-H37 COD. 00270  
100x70-H34 COD. 00360



## lettino OCEANO

PRODOTTO TOP QUALITY

**Lettino impilabile Art. 1124** COD. 00358  
 struttura polipropilene / textilene:  
**bianco - tortora - antracite/retina nera**

Misure 68x193  
 Schienale reclinabile 5 posizioni  
 Piedini antiscivolo (parte anteriore) + **rotelline (parte posteriore)**

- BANCALE DA 18 pz.  
 Apertura imballo 1/6 pz. + 20,00 netto  
 Apertura imballo 7/17 pz. + 10,00 netto



**Tavolino multiuso Art. 1125** COD. 0088  
 struttura polipropilene:  
**bianco - tortora - antracite**

Misure 45x45 H45 - IMBALLO 1 pz.

con retina top quality

**Serge Ferrari**  
 group

**NORMALMENTE IN PRONTA CONSEGNA**





Art. 1797/8 Set **Miami**

POLIPROPILENE EFFETTO WICKER ANTRACITE  
cuscinetti compresi

COD. 00540

1 DIVANETTO - L131-P58-H79  
2 POLTRONE - L75-P58-H79  
1 TAVOLINO - L70-P48-H37  
non acquistabili singolarmente

**NORMALMENTE IN PRONTA CONSEGNA**



Art. 1797/4 Set **Lubecca**

COD. 00650

POLIPROPILENE ANTRACITE/GRIGIO  
cuscinetti compresi

1 DIVANETTO - L119-P68-H76  
2 POLTRONE - L68-P68-H76  
1 TAVOLINO - L80-P50-H45

non acquistabili singolarmente  
per poltrone singole vedi pag. dopo Morgana Lounge

**NORMALMENTE IN PRONTA CONSEGNA**



Art. 1127 **Nizza**

TUTTO POLIPROPILENE - impilabile **128,00**

PALLETS 28 PZ. - ORDINE MINIMO 2 PALLETS  
MONO COLORE: BIANCO-ANTRACITE







Art. 1797/6 Set **Portocervo**

POLIPROPILENE **BIANCO** / CUSCINERIA **TORTORA** COD. 001380

Composto da:  
1 DIVANETTO - L128-P67-H80  
2 POLTRONE - L67-P67-H80  
1 TAVOLINO - L62-P62-H40

**NORMALMENTE IN PRONTA CONSEGNA**  
(fino ad esaurimento scorte stagionali)



## Art. 1784 Sofà componibile

POLIPROPILENE: **BIANCO - TORTORA - ANTRACITE - VERDE**

TESSUTO E GOMMA PER ESTERNI:  
**ROSA QUARZO - GRIGIO ----- SUMBRELLA: VERDINO - VERDONE**

Tempi in stagione 40/50 gg.

cuscino volante  
grigio - antracite  
bianco - verdino  
arancio

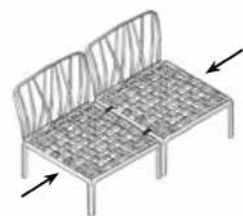

H seduta 47



cuscino schienale (Htotale 88)

Prof. 78 x Larg. 70 + 5 per bracciolo

VERDINO VERDONE	ROSA QUARZO GRIGIO	
COD. 00890	COD. 00790	POLTRONA 2 BRACCIOLI CUSCINI SEDUTA/SCHIENALE
COD. 00750	COD. 00610	ELEMENTO SEDUTA CON CUSCINI SEDUTA/SCHIENALE
COD. 0090	COD. 0090	ELEMENTO BRACCIOLO
COD. 00990	COD. 00790	ELEMENTO ANGOLO CON CUSCINI SEDUTA/SCHIENALE
COD. 00220	COD. 00220	TAVOLINO COFFEE TABLE (piano in polipropilene) 70x70xH33
COD. 00470	COD. 00350	POUF CON CUSCINO SEDUTA
COD. 00120	COD. 0090	CUSCINETTI VOLANTI
COD. 003250	COD. 002710	CHAISE LONGUE 2 POSTI CON BALDACCHINO: come foto, escluso tavolino laterale COD. 00220 composto da: 2 elementi seduta + 2 braccioli + 2 pouf con cuscino + 2 cuscini poggiatesta + baldacchino INGOMBRO: L165 - P163 - H188
COD. 004190	COD. 003410	LETTINO 2 POSTI CON BALDACCHINO: composto da: 2 elementi seduta + 2 braccioli + 4 pouf con cuscino + 2 cuscini poggiatesta + baldacchino INGOMBRO: L165 - P233 - H188



Art. 1793/.... SALOTTINO LOUNGE DESIGN - IMPILABILE

■ POLIPROPILENE: BIANCO - ANTRACITE - TORTORA

■ **POLTRONCINA LOUNGE ART. 1793/1** COD. 00180  
L67-P71-HS41-HT87  
accessorio cuscinetto seduta, spessore 7 cm tessuto grigio COD. 0098  
IMBALLO N. 4 pz. - Imballo speciale 1/3 pz. + 10,00 netto

■ **DIVANETTO ART. 1793/2** COD. 00298  
L116-P70-HS41-HT87  
accessorio cuscinetto seduta, spessore 7 cm tessuto grigio COD. 00178  
IMBALLO N. 1 pz.

■ **TAVOLINO ART. 1793/3** COD. 00170  
L100-P60-H40  
IMBALLO N. 1 pz.

TEMPI IN STAGIONE 30/40 GG



Art. 1260/.... POLTRONCINA LOUNGE DESIGN - IMPILABILE

■ POLIPROPILENE: BIANCO - ANTRACITE - GERANIO - LIME - VERDE OLIVA

■ **POLTRONCINA LOUNGE ART. 1260/1** COD. 00196  
L67-P71-HS41-HT87  
IMBALLO N. 4 pz. - Imballo speciale 1/3 pz. + 10,00 netto  
accessorio cuscino sedile/schienale, tessuto color lino COD. 00136

■ **TAVOLINO ART. 1260/3** COD. 0098  
Ø50 - H40  
IMBALLO N. 1 pz.

TEMPI IN STAGIONE 30/40 GG





## Art. 1821/12 Real Table

- **VERO MASSELLO DI TEAK INDONESIANO**  
CON FINITURA OLIO NATURALE
  - MISURE: Ø 150 (8 persone) - H 75 COD. 001880
  - MISURE: Ø 180 (10 persone) - H 75 COD. 002190
- portavivande girevole

Note: il teak è un'essenza tropicale giungendo in Europa con clima diverso tende a seccarsi, potrebbero comparire in superficie tracce bianche di resina secca. Per ravvivare e conservare l'immagine unica di questa essenza, basta trattarla con l'apposito olio per dare e conservare freschezza, lucentezza e protezione. Consigliabile inizio e fine stagione.

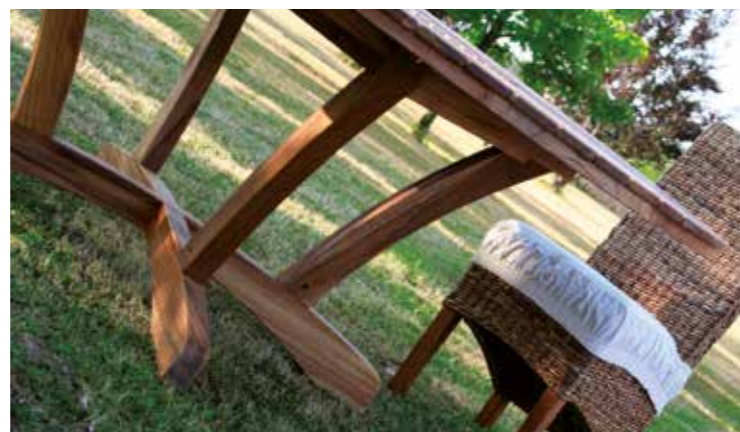

## Art. 1820/1 Resort Chair

- STRUTTURA BANANO - L47 x P52 x HS51 x HT101
- SEDILE CUSCINO ecrù COD. 00228



## Art. 1821/3 Folding Chair

cuscinetto ecrù idrorepellente  
tax IMBALLO 2 pz.

COD. 00195 cad.



## Art. 1820/9 Croco Sofà

- 1820/9 P poltrona L 84 x P 87 COD. 00790
- 1820/9 D2 divano 2p L 164 x P 87 COD. 001690
- 1820/9 D3 divano 3p L 195 x P 87 COD. 001990
- 1820/9 T tavolino 130 x 60 x H 35 COD. 00460

## linea RESORT ETNICO

(INTRECCIO DI BANANO\* NATURALE)

\*non resistente agli agenti atmosferici,  
specialmente alla pioggia

## NORMALMENTE IN PRONTA CONSEGNA

(fino ad esaurimento scorte stagionali)

## Art. 1820/5 Clito Mini Sofà

- 1820/5 P poltrona L 75 x P 78 COD. 00520
- 1820/5 D divanetto L 125 x P 78 COD. 00870
- 1820/5 T tavolino 85 x 45 x H 40 COD. 00290



# OFFICE & COMUNITÀ

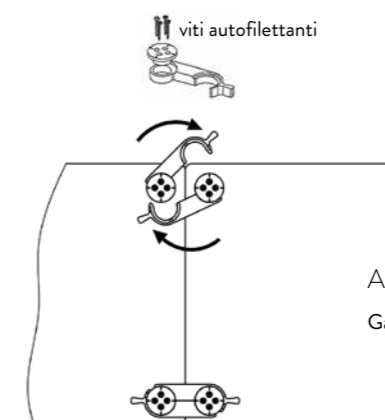

Accessorio Art. 1050 **GPR GANCI** COD. 0016 cad.  
Gancio per prolunghe, con gancio si intende maschio / femmina

montaggio sui top non compreso



## Art. 1065 **DUAL**

Ingombro terra gamba 76 - Polipropilene nero

solo base per piano: 150/200 x 80/ 90max

COD. 00550

**TEMPI 20/30 GG.**

solo piano nobilitato 20 mm

150x90: bianco COD. 00227 - colori speciali COD. 00296

180x90: bianco COD. 00279 - colori speciali COD. 00358

200x90: bianco COD. 00335 - colori speciali COD. 00429

■ COSTI GESTIONE TECNICA, ORDINI SOTTO:

5 PIANI + € 40,00 NETTI - 10 PIANI + € 30,00 NETTI - OLTRE 10 PIANI NESSUN SUPPLEMENTO



Sedie  
pieghevoli  
vedi pag. 181

### NOTA TECNICA

azionando leva di chiusura,  
con il ribaltamento del piano,  
in automatico le gambe  
divaricano,  
permettendo di riporre i tavoli  
in spazi contenuti (vedi foto)



Art. 1064/3  
Fargo Round



SOLO STRUTTURA

verniciata nera COD. 003160  
cromata COD. 003680  
Tavolo completo sommare base piano

PIANI NOBILITATO 19mm: BIANCO - GRIGIO - NERO  
diametro 160 COD. 00970  
diametro 180 COD. 00990  
ellittico 240x150 COD. 001240



Art. 1064/2  
Fargo Rectangular

SOLO STRUTTURA

per piano da 200 a 260 v. nera  
per piano da 200 a 260 cromata  
per piano da 280 a 320 v. nera  
per piano da 280 a 320 cromata

COD. 002730  
COD. 003145  
COD. 002960  
COD. 003430

PIANI NOBILITATO 19mm: BIANCO - GRIGIO - NERO  
200 x 80/90/100 COD. 00670  
220 x 80/90/100 COD. 00770  
240 x 80/90/100 COD. 00860  
260 x 80/90/100 COD. 00960  
280 x 80/90/100 COD. 001060  
300 x 80/90/100 COD. 001160  
320 x 80/90/100 COD. 001280

Tavolo completo sommare base piano



Art. 1062 Omega

SOLO STRUTTURA piano cliente  
cromata COD. 00380  
**NORMALMENTE IN PRONTA CONSEGNA**

PIANI NOBILITATO 19mm  
colori vedi Art. 1060 (pag. 21)  
160 x 80/90 COD. 00340  
180 x 80/90 COD. 00380  
200 x 80/90 COD. 00430  
**TEMPI 20/30 GG**

misura a terra gamba 60 cm



Art. 1015 Kit Pratico



set 4 gambe nere COD. 00180  
set 4 gambe cromate COD. 00190  
**NORMALMENTE IN PRONTA CONSEGNA**  
Per scelta piani Art. 1060



Piedino regolabile





Sedia 253/4G Carnaby 4G

## Art. 673 Atene **Noir**

■ **NORMALMENTE IN PRONTA CONSEGNA**

■ VETRO TRASPARENTE temperato 12 mm - H 76	140x80	160x85	180x90
■ NERO	COD. 00750	COD. 00770	COD. 00790
■ SOLO BASE NERO piano cliente	COD. 00475	COD. 00485	COD. 00495

## Art. 673 Atene **Chrome**

■ **NORMALMENTE IN PRONTA CONSEGNA**

■ STRUTTURA CROMATA/PIANI VETRO TEMPERATO 12 MM TRASPARENTE - H 77

■ VETRO TRASPARENTE temperato 12 mm - H 76	140x80	160x85	180x90
■ CROMO	COD. 00750	COD. 00770	COD. 00790
■ SOLO BASE CROMO piano cliente	COD. 00475	COD. 00485	COD. 00495

sedia eliminata





## Art. 641/2 Armony

■ **NORMALMENTE IN PRONTA CONSEGNA**

■ **PIANI VETRO TEMPERATO 10 MM - H 76:**    **TRASPARENTE**    **EXTRAWHITE**

■ **VERNICIATO: bianco** (vedi pag. dopo)

■ Ø 80 (base Ø 44)	COD. 00660	COD. 00690
■ Ø 100 (base Ø 70)	COD. 001000	-
■ Ø 120 (base Ø 70)	COD. 001080	COD. 001150

per piani più grandi vedi Art. 618 Bramante

■ **cromato**

■ Ø 80 (base Ø 44)	COD. 00700	COD. 00730
■ Ø 100 (base Ø 70)	COD. 001060	-
■ Ø 120 (base Ø 70)	COD. 001140	COD. 001210



## Art. 618 Bramante

■ **NORMALMENTE IN PRONTA CONSEGNA**

■ **BASE ACCIAIO VERNICIATA BIANCA**  
PIANO VETRO TEMPERATO EXTRAWHITE 10 MM - H 75

■ **MISURE:**

<b>ellittico 110 x 160</b>	COD. 001490
<b>Ø 130</b>	COD. 001490

PER DIMENSIONI PIÙ PICCOLE VEDI ART. 641/2 ARMONY







## Brema

ecopelle  
nera

stoffa cliente

finta pelle  
colorata  
(vedi pag. dopo)  
COD. 00750  
COD. 001060  
COD. 001290

OMOLOGATO 1iM  
finta pelle ignifuga  
(vedi pag. dopo)  
COD. 00830  
COD. 001160  
-

Art. **409/1** Poltrona 1P COD. 00680 COD. 00640 mt. 3,00  
Art. **409/2** Divano 2P COD. 00970 COD. 00910 mt. 5,50  
Art. **409/3** Divano 3P COD. 001190 COD. 001130 mt. 6,90

struttura in legno, faesite truciolare - piedini in metallo cromato

TEMPI 30 GG

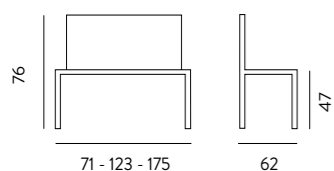

## Halifax

solo ecopelle nera

struttura metallo tubolare quadro cromato

Art. **434/1** Poltrona 1P COD. 00790  
Art. **434/2** Divano 2P COD. 001180

**NORMALMENTE IN PRONTA CONSEGNA  
DA GENNAIO 24**

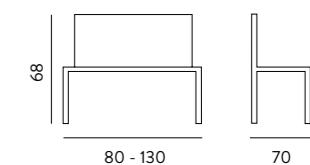



# FINTA PELLE

COMPOSIZIONE: 88% PVC  
12% PL  
PESO: 430 GR/M<sup>2</sup>  
ABRASIONE: >100.000

Piedino regolabile

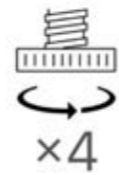

## Techne

Struttura metallo cromato  
Cuscineria truciolare/poliuretano espanso

■ TEMPI 30/40 GG

# FINTA PELLE IGNIFUGA

COMPOSIZIONE: 85% PVC  
14% PES - 1% PU  
PESO: 550 GR/M<sup>2</sup>  
ABRASIONE: >100.000  
TEST: IIM - BS 5852 - EN 1021  
CARATTERISTICHE:  
IGNIFUGO



poltrona Art. 990/1 L76xP69xH72 - HS44

divanetto 2P Art. 990/2 L177xP69xH72 - HS44

ecopelle PU nera COD. 00998  
finta pelle COD. 001159  
finta pelle ignifuga COD. 001288

ecopelle PU nera COD. 001548  
finta pelle COD. 001729  
finta pelle ignifuga COD. 001886



Bond - fintapelle: bianca - nera - tortora  
Fintapelle ignifuga

POLTRONA	DIVANETTO
COD. 00556	COD. 00795
COD. 00629	COD. 00886

**Omologato liM**

Bond	COD. 00577	COD. 00840
Fintapelle ignifuga	COD. 00650	COD. 00948

COLORI STOFFE VEDI PAGINA 306 (KROLL)

TEMPI 20/30 GG



Art. 991/1 Tube poltroncina

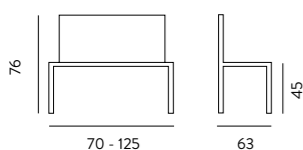

Art. 991/2 Tube divanetto



tavolino eliminato



**Executive**

struttura metallo tubolare Ø cromato

Art. 416/5 Divano 2P large 145cm solo ecopelle nera COD. 001190  
NORMALMENTE IN PRONTA CONSEGNA

VERSIONE PLUS ecopelle vari colori / stoffa cliente TEMPI 30/40 GG

Art. 416/1 Poltrona 1P COD. 001790  
Art. 416/2 Divano 2P COD. 002420

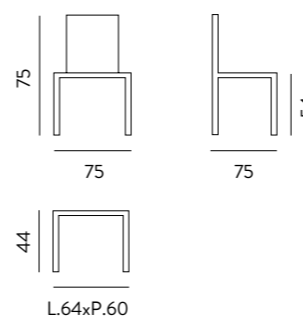
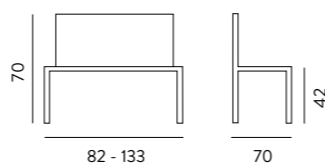

Art. 856 Ragni

- TEMPI 20 GG.
- STRUTTURA TONDINO CROMATO
- PIANO NOBILITATO:

bianco - olmo - noce - cemento - tortora	
Ø46 - H48	COD. 00186
Ø46 - H53	COD. 00186

**Bikini**

- IMBALLO N. 1 pz.
- NORMALMENTE IN PRONTA CONSEGNA

- STRUTTURA: CROMATA
- SEDILI ECOPELLE:

	bianco	nero
Art. 427/1 POLTRONA	COD. 00890	COD. 00890
Art. 427/2 POUF	COD. 00490	COD. 00490





105 x 55  
70 x 45



## Art. 851 Filho

■ TEMPI 20 GG.

- STRUTTURA TONDINO CROMATO
- PIANO NOBILITATO: **bianco - olmo - noce - cemento - tortora**
- L60 - P60 - H33                      COD. 00228
- L70 - P45 - H33                      COD. 00228
- L105 - P55 - H33                    COD. 00257



60 x 60



## Art. 864 Stylo

- IMBALLO N. 1 pz.
- **NORMALMENTE IN PRONTA CONSEGNA**
- POLIPROPILENE / ALLUMINIO NERO                      COD. 00136
- MISURE: Ø 47 x H 174

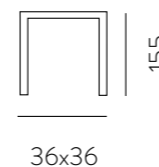

## Art. 867 Dumbo

- IMBALLO N. 1 pz.
- **NORMALMENTE IN PRONTA CONSEGNA**
- COLONNA FAGGIO NATURALE CON BASE ZAVORRATA
- POLIPROPILENE: **bianco - nero**                      COD. 00128



## Art. 982 Iso Chair

acripol ignifugo: **blu-rosso-nero** COD. 0089

**NORMALMENTE IN PRONTA CONSEGNA**

SU ORDINAZIONE 40 GG. con acconto  
BRACCIOLO CON TAVOLETTA + € 44,00  
COPPIA BRACCIOLI + € 38,00



acripol



Rosso

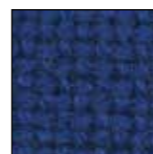

Blu



Nero

## Art. 982/P Iso-Panka

**TEMPI 30 GG. - NO PROMO**

- 2 MODULI L. 110-P. 62
- 3 MODULI L. 165-P. 62
- 4 MODULI L. 220-P. 62

acripol  
ecopelle  
COD. 00620  
COD. 00810  
COD. 00890

# ATTESA CONFERENZA

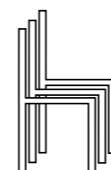

## Art. 987 Meeting Chair

struttura **cromata/ABS ignifugo nero** COD. 0079  
dotata di gancio saldato per allineamento file  
**NORMALMENTE IN PRONTA CONSEGNA**

Gancio per file



## Alina Panka

3 sedute Art. 986.2761 IG \* L152  
4 sedute Art. 986.2762 IG \* L202  
5 sedute Art. 986.2763 IG \* L252

COD. 00780  
COD. 00940  
COD. 001090

CON TAVOLINO + sedute

2 sedute Art. 986.2771 IG \* L152  
3 sedute Art. 986.2772 IG \* L202  
4 sedute Art. 986.2773 IG \* L252

COD. 00780  
COD. 00940  
COD. 001090

COLORI SEDUTE

panna soft - grigio chiaro - antracite

\* **IGNIFUGHE** classe 1

P52 - H82 - HS46

**TEMPI 30 GG. - NO PROMO**





**Sedia**

**Art. 986.2675**  
**Art. 986.2675 IG \***  
 L51-P52-HS46-HT82  
 imballo 4 pz. TAX

COD. 00136  
 COD. 00192

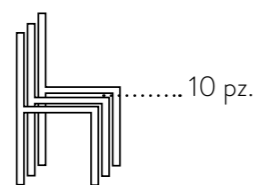

**gancio**  
**Art. 986.2941** COD. 0034  
 imballo 10 pz. TAX

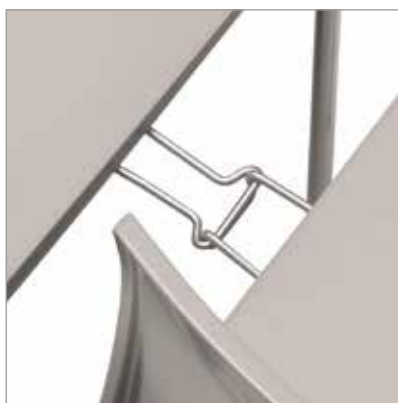

**Accessorio tavoletta antipanico con movimento a ribalta**  
**Art. 986.2946**  
 COD. 00162  
 imballo 2 pz. TAX



**carrello**  
**Art. 986.2944**  
 COD. 00215  
 imballo 2 pz. TAX

**maniglione**  
**Art. 986.2948**  
 COD. 0060



**Sedia 4 gambe 15pz.**  
**Sedia con braccioli 15pz.**  
**Sedia slitta 20pz.**



**Sedia con braccioli**

**Art. 986.2676**  
**Art. 986.2676 IG \***  
 L53-P52-HS46-HT82  
 H bracciolo 67  
 imballo 2 pz. TAX

COD. 00202  
 COD. 00258

# Alina Conference

- struttura cromata  
 polipropilene: bianco panna - antracite - grigio chiaro - tortora
- struttura antracite / polipropilene antracite

- \* **IGNIFUGA** struttura cromata  
 polipropilene: bianco panna - antracite - grigio chiaro



**Sedia con base a slitta**

base: cromata - verniciata antracite

**Art. 986.2677**  
**Art. 986.2677 IG \***  
 L53-P52-HS46-HT82  
 imballo 2 pz. TAX

COD. 00179  
 COD. 00232





## Art. 968 Twister

- IMBALLO N. 4 pz.  
Imballo speciale 1/3 pz. + 10,00 netto
- **NORMALMENTE IN PRONTA CONSEGNA**
- ALZO A GAS
- CUSCINO IN TINTA ECOPELLE
- STRUTTURA NERA COD. 00188
- SEDILI POLIPROPILENE:  
bianco - grigio chiaro - ottanio

### OPTIONAL



Art. 998 RPQ  
set parquet  
COD. 0018



Art. 998 PDF  
set fisso  
COD. 0016

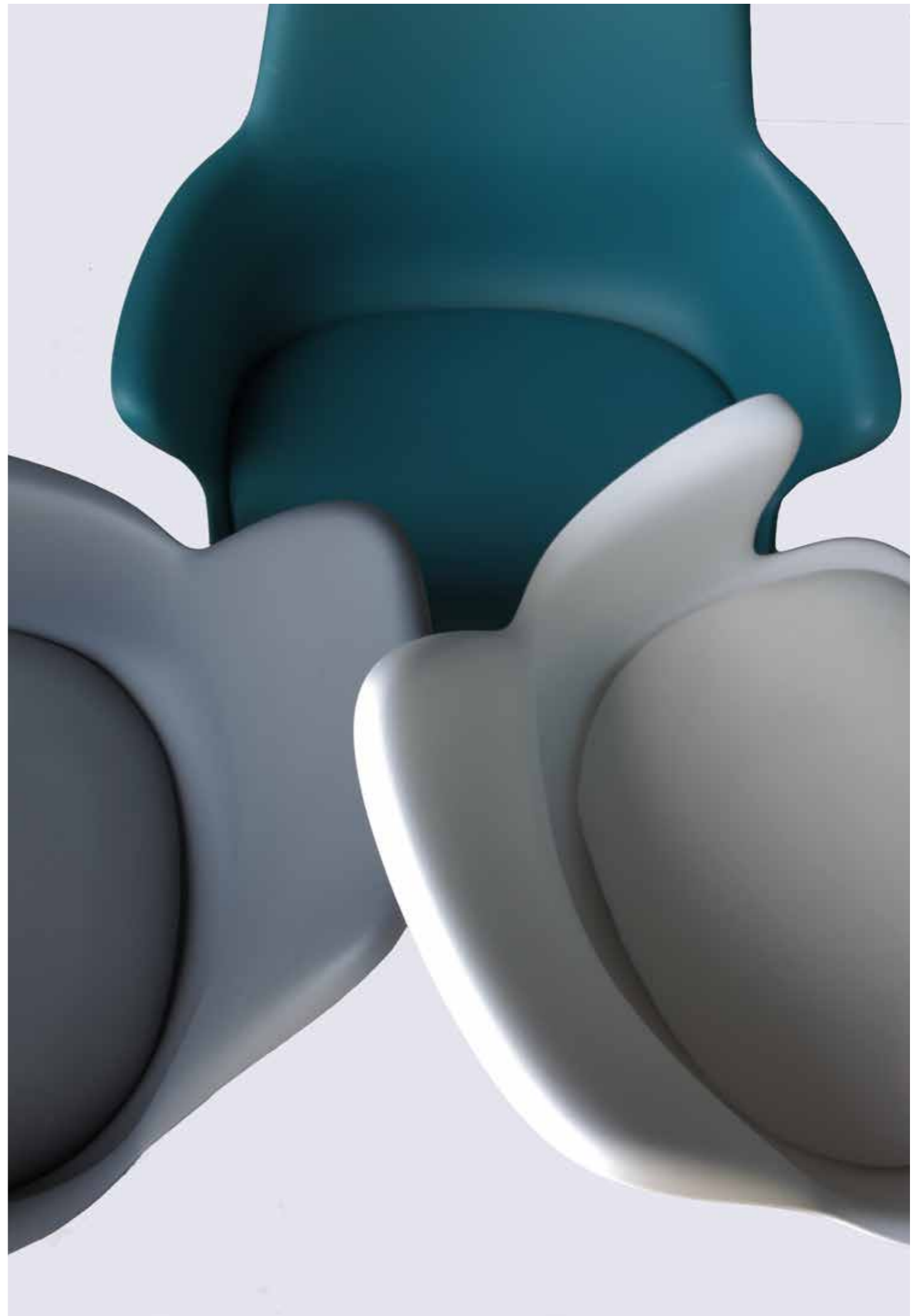
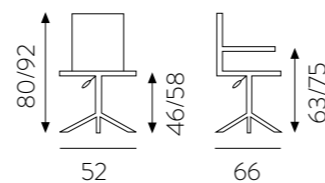



## Art. 964 Tutti Frutti

- IMBALLO N. 1 pz.
- **NORMALMENTE IN PRONTA CONSEGNA**
- ALZO A GAS
- CUSCINO IN TINTA ECOPELLE
- STRUTTURA CROMATO      COD. 00176
- SEDILI POLIPROPILENE:  
verde - turchese - arancio - rosso - nero - bianco  
viola - giallo - grigio

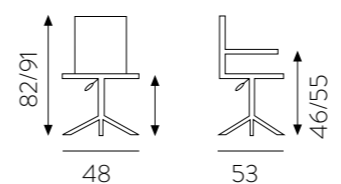

OPTIONAL



Art. 998 RPQ  
set parquet  
COD. 0018



Art. 998 PDF  
set fisso  
COD. 0016



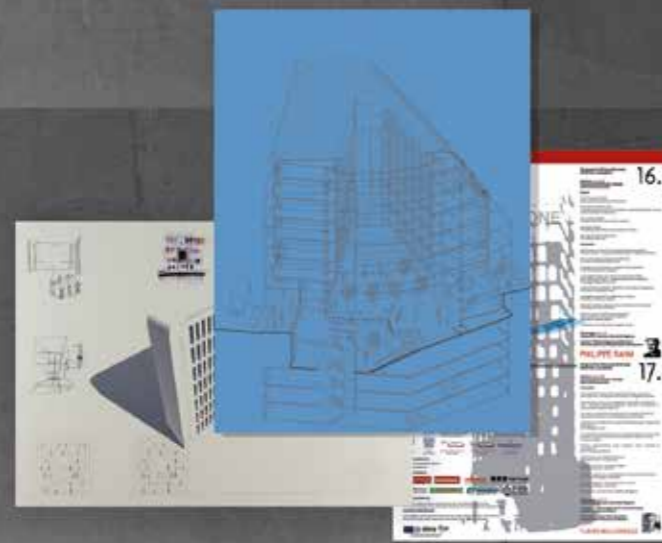

**CATAS**  
CERTIFICATA EN-1335 B

**Michelangelo**

- SEDILE GIREVOLE CON ALZO A GAS
- SCHIENALE CONTATTO PERMANENTE - UP & DOWN
- PARTI IMBOTTITE SPORGENTI (non rovinano collant)
- CROCIERA FIBRA DI NYLON NERO

- ACRIPOL IGNIFUGO CLASSE 1M: **nero**

**blu** (su ordinazione min. 10 pz.)

ART. 939/SB SENZA BRACCIOLI

ART. 939/BF CON BRACCIOLI FISSI

ART. 939/BR CON BRACCIOLI REGOLABILI

- **NORMALMENTE IN PRONTA CONSEGNA**

COD. 00240  
COD. 00280  
COD. 00300



coppia braccioli regolabili

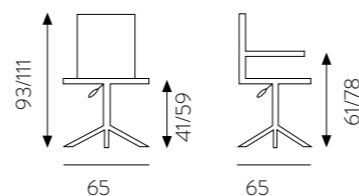

Art. 944 **Thor**

- **NORMALMENTE IN PRONTA CONSEGNA**

- SEDILE GIREVOLE CON ALZO A GAS
- SCHIENALE CONTATTO PERMANENTE - UP & DOWN

- SEDILI ACRIPOL:

**blu-nero**

COD. 00190

SOLO CON BRACCIOLI

**rosso**

COD. 00180

SOLO CON BRACCIOLI

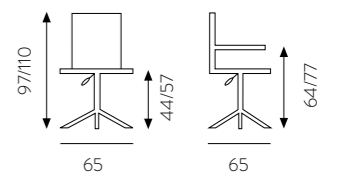

**acripol**



Rosso



Blu



Nero

OPTIONAL

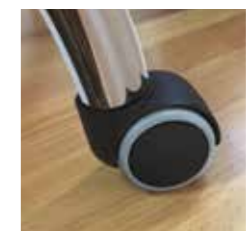

Art. 998 RPQ  
set parquet  
COD. 0018



Art. 998 PDF  
set fisso  
COD. 0016

# OMOLOGATE E CERTIFICATE EN 1335 B ORDINE MINIMO 12 PZ.



Art. 951.457 **Quantum**  
L67 - P66 - HS44/57 - HT102/115

- Ruote rigide frenate d.50
- Base nylon d.680
- Meccanismo synchro 4 posizioni
- Schienale in rete nera con supporto lombare
- Senza braccioli
- CERTIFICATA UNI EN 1335 B
- OMOLOGATA con Schienale rete nera e tessuto acripol ignifugo BOND e con finta pelle ignifuga BOND LISTINO € 378
- FINTAPELLE LISTINO € 390
- COPPIA BRACCIOLI TEKNO € 32,00
- COPPIA BRACCIOLI REGOLABILI FRIZ 1D € 44,00

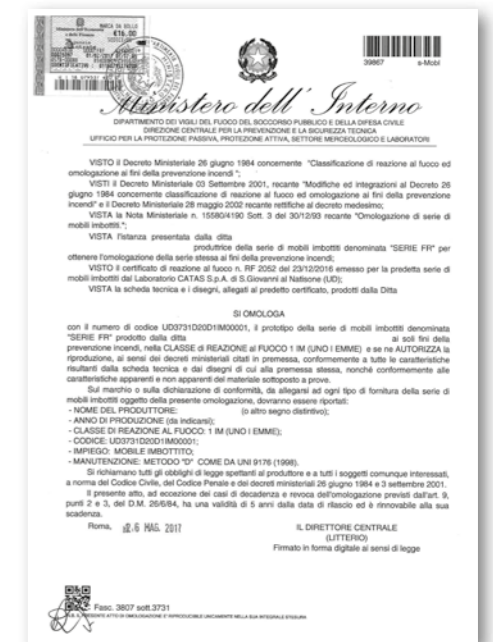

## CAT. 300 BOND IGNIFUGO FR



Art. 951.341 **Logaritmo**  
L65 - P63 - HS40/53 - HT104/120

- Ruote rigide frenate d.50
- Base nylon d.680
- Meccanismo synchro 4 posizioni
- Interno sedile in legno
- Schienale con supporto lombare
- Senza braccioli
- CERTIFICATA UNI EN 1335 B
- OMOLOGATA con tessuto: acripol ignifugo BOND e con finta pelle ignifuga BOND LISTINO € 416
- FINTAPELLE LISTINO € 436
- COPPIA BRACCIOLI TEKNO € 32,00
- COPPIA BRACCIOLI REGOLABILI FRIZ 1D € 44,00

## CAT. 400 F. P. (ecopelle IGNIFUGA)

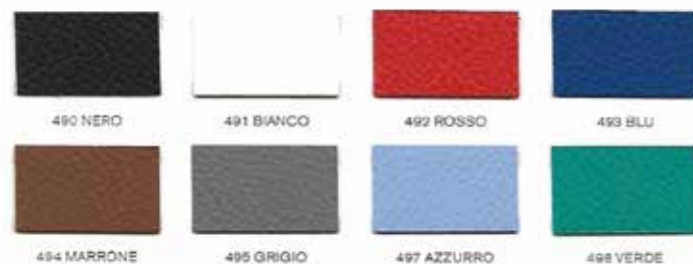

Coppia braccioli Tekno



Coppia braccioli Friz 1D regolabili Up&Down



## Art. 931 Pixel

- IMBALLO N. 1 pz.
- **NORMALMENTE IN PRONTA CONSEGNA**
- SEDILE GIREVOLE CON ALZO A GAS
- MECCANISMO BASCULANTE
- STRUTTURA
- SCHIENALE: TECNORETE MICROFORATA
- SEDILI: PUMA NERO

CROMATO

COD. 00228

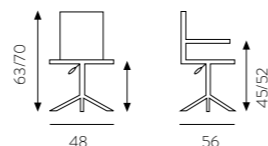

OPTIONAL



Art. 998 RPQ  
set parquet  
COD. 0018

Art. 998 PDF  
set fisso  
COD. 0016



## Art. 932 Speed

- IMBALLO N. 1 pz.
- **NORMALMENTE IN PRONTA CONSEGNA**
- SEDILE GIREVOLE CON ALZO A GAS
- MECCANISMO BASCULANTE
- STRUTTURA
- SEDILI: PUMA NERO con particolari ecopelle

CROMATO

COD. 00238

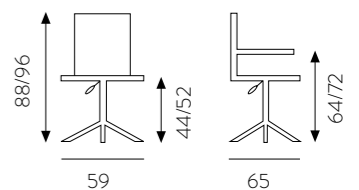



traslabile

pulsantino



braccio  
regolabile e traslabile

OPTIONAL



Art. 998 RPQ  
set parquet  
COD. 0018



Art. 998 PDF  
set fisso  
COD. 0016

## Art. 937 Urus

- IMBALLO N. 1 pz.
- **NORMALMENTE IN PRONTA CONSEGNA**
- SEDILE GIREVOLE CON ALZO A GAS - BASE DESIGN
- SEDUTA FISSA - BRACCIOLI REGOLABILI E TRASLANTI
- TESSUTO TECNICO / RETE **NERA**

COD. 00228

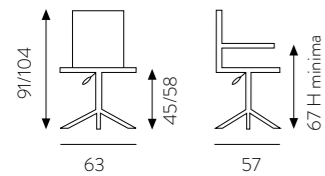

## Art. 302 Delta

- IMBALLO N. 2 pz.  
Imballo speciale 1 pz. + 10,00 netto
- **NORMALMENTE IN PRONTA CONSEGNA**
- STRUTTURA: CROMATO
- SEDILI  
CUOIO RIGENERATO: **nero** COD. 00186

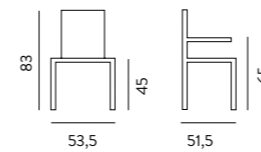
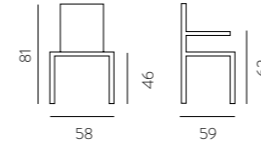

## Art. 981 Kubica

- IMBALLO N. 2 pz.  
Imballo speciale 1 pz. + 10,00 netto
- **NORMALMENTE IN PRONTA CONSEGNA**
- STRUTTURA: CROMATO
- ECOPELLE: **bianca - nera** COD. 00346





## Art. 988 Silla

- IMBALLO N. 2 pz.  
Imballo speciale 1 pz. + 10,00 netto
- **NORMALMENTE IN PRONTA CONSEGNA**
- STRUTTURA TUBOLARE NERO
- STOFFA nera COD. 00240



poggiareni regolabile

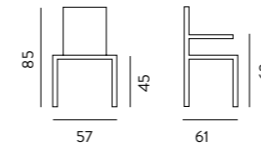

## Art. 938 Jet

- IMBALLO N. 1 pz.
- **NORMALMENTE IN PRONTA CONSEGNA**
- SEDILE GIREVOLE CON ALZO A GAS - BASE DESIGN
- **REGOLAZIONE SYNCRON** (sedile/schienale bloccabile 4 posizioni) con antishok per evitare, dopo lo sblocco, l'impatto brusco sulla schiena
- TESSUTO TECNICO / RETE NERO COD. 00340

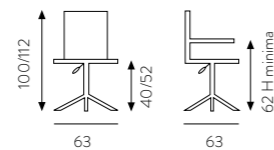

pulsantino

bracciolo regolabile

### OPTIONAL



Art. 998 RPQ  
set parquet  
COD. 0018



Art. 998 PDF  
set fisso  
COD. 0016





poggiatesta regolabile

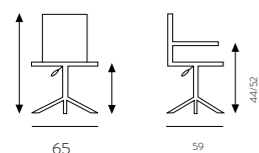

65

59



meccanismo sincron  
regola inclinazione  
sedile/schienale

## Art. 927 Gravity

- IMBALLO N. 1 pz.
- **NORMALMENTE IN PRONTA CONSEGNA**
- SEDILE GIREVOLE CON ALZO A GAS
- MECCANISMO SINCRON
- STRUTTURA
- SCHIENALE: TECNORETE MICROFORATA
- SEDILI: PUMA NERO

COD. 00340



alzo a gas



## Art. 929 Futura

- IMBALLO N. 1 pz.
- **NORMALMENTE IN PRONTA CONSEGNA**
- SEDILE GIREVOLE CON ALZO A GAS
- MECCANISMO SINCRON (regola inclinazione sedile/schienale)
- BRACCIOLI REGOLABILI IN ALTEZZA
- POGGIARENI
- RUOTE GOMMATE DI SERIE
- PARTICOLARI COLOR ALLUMINIO
- STRUTTURA: NYLON NERO
- SCHIENALE: TECNORETE MICROFORATA
- SEDILI: PUMA NERO

929/A ALTA

929/B BASSA (SENZA POGGIATESTA)

COD. 00396

COD. 00376

braccioli  
regolabili

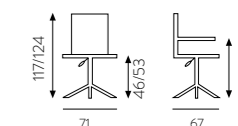

71

67

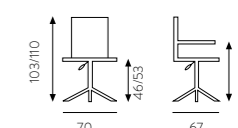

70

67





## Mod. Sistema

- SEDILE GIREVOLE CON ALZO A GAS
- MECCANISMO BASCULANTE
- STRUTTURA CROMATA
- SEDILI / SCHIENALE ECOPELLE: bianco - nero - grigio titanio

**NORMALMENTE IN PRONTA CONSEGNA**

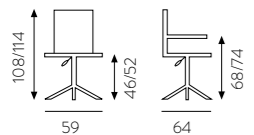

Art. 928/A Sistema alta

COD. 00580

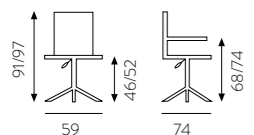

Art. 928/B Sistema bassa

COD. 00550

OPTIONAL



Art. 998 RPQ  
set parquet  
COD. 0018



Art. 998 PDF  
set fisso  
COD. 0016

NERO



GRIGIO TITANIO



BIANCO



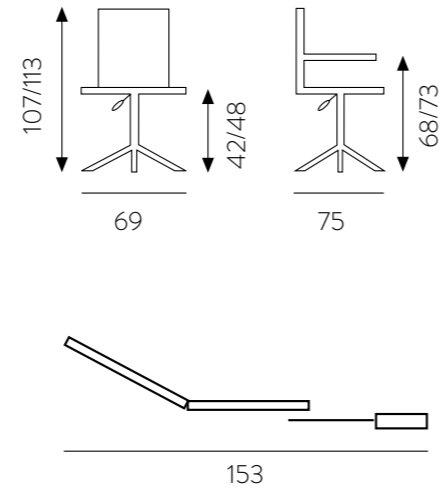

## Art. 926 Galaxy

- IMBALLO N. 1 pz.
- **NORMALMENTE IN PRONTA CONSEGNA**
- SEDILE GIREVOLE CON ALZO A GAS
- MECCANISMO RECLINABILE
- BASE CROMATA
- SCHIENALE: ECOPELLE
- SEDILI: ECOPELLE nera COD. 00490
- SET RUOTE PARQUET + € 16,00



## Art. 923 Revolving

- IMBALLO N. 1 pz.
- **NORMALMENTE IN PRONTA CONSEGNA**
- SEDILE GIREVOLE CON ALZO A GAS
- MECCANISMO BASCULANTE
- BASE: IN FUSIONE CROMATA
- SCHIENALE: ECOPELLE
- SEDILI: PELLE nera

COD. 00560

### OPTIONAL



Art. 998 RPQ  
set parquet  
COD. 0018



Art. 998 PDF  
set fisso  
COD. 0016

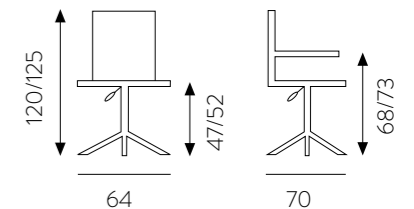





OPTIONAL  
ROTELLE FORO + € 30,00



## Art. 915/A Project

- IMBALLO N. 1 pz.
- TEMPI 30 GG CIRCA
- SEDILE GIREVOLE CON ALZO A GAS
- MECCANISMO OSCILLANTE MULTIBLOCK
- RUOTE GOMMATE DI SERIE
- BASE: FUSIONE D'ALLUMINIO DESIGN
- ECOPELLE IGNIFUGA: bianca-nera-grigia
- VERA PELLE: bianca-nera-grigia

COD. 00990  
COD. 001280

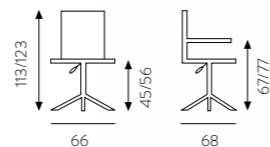

POLTRONCINA INTERLOCUTORE  
CONSIGLIATA

### Art. 981 Kubica

- STRUTTURA CROMATA
- ECOPELLE: bianca - nera

COD. 00346



Art. 977/2 Key cross

Art. 977/1 Key office

## Art. 977/2 Key cross

- IMBALLO N. 1 pz.
- TEMPI 30 GG CIRCA
- STRUTTURA cromo/SEDILE ECOPELLE:  
bianco-tortora chiaro-tortora fango-nero  
stoffa cliente (1,5x1,4)

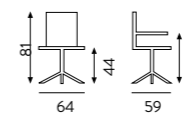

COD. 00680  
COD. 00640

## Art. 977/1 Key office

- IMBALLO N. 1 pz.
- TEMPI 30 GG CIRCA
- STRUTTURA cromo/SEDILE ECOPELLE:  
bianco-tortora chiaro-tortora fango-antracite  
stoffa cliente (1,5x1,4)

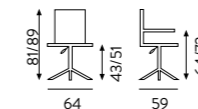

COD. 00680  
COD. 00640

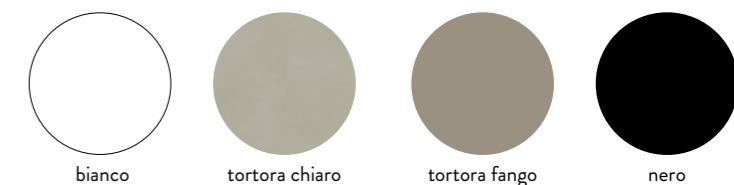

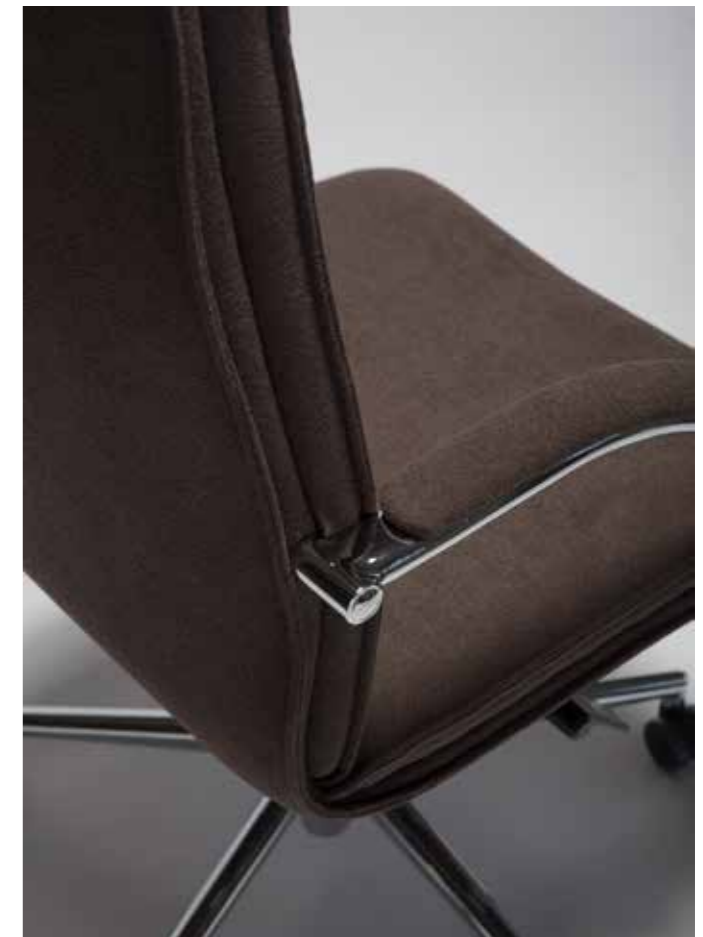

Art. 911 **KROLL**

**DIREZIONALE CERTIFICATA 1335-C / OMOLOGATA 11M**

**CAT. 300 BOND IGNIFUGO FR**



**CAT. 400 F. P. (ecopelle IGNIFUGA)**

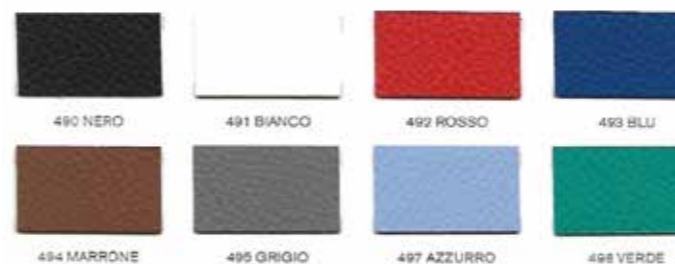

L60 - P70 - HS42/51 - HT112/122

- Ruote gommata
- Base piramidale cromata
- Meccanismo oscillante monoblock
- Scocca multistrato di faggio
- Braccioli in acciaio cromato tappezzati

CERTIFICATA UNI EN 1335 B

OMOLOGATA con tessuto:

acripol ignifugo BOND

finta pelle ignifuga

TEMPI 30/40 GG.

COD. 00660

COD. 00695



# PL

Einrichtung Design  
S I N C E 1 9 9 9

Gastronomie & Eisbedarf GbR  
Rotherstr. 15  
90530 Wendelstein

Tel.: +49 (0) 911 14 89 87 16  
Tel: +49 (0) 171 75 10 137 ( DE )  
Tel: +49 (0) 160 44 93 067 ( DE )

[info@gastronomie-eisbedarf.de](mailto:info@gastronomie-eisbedarf.de)  
[www.gastronomie-eisbedarf.de](http://www.gastronomie-eisbedarf.de)